

UNILUX



CATALOGUE 2026

A woman with dark hair tied back, wearing a dark blue shirt with white polka dots, is smiling and looking at a silver laptop. She is sitting at a wooden desk. The background is a blurred office setting with a window and curtains.

UNILUX

YOUR
WELL-BEING
AT WORK
IS OUR
PRIORITY

SUMMARY

ABOUT US	4
ECO-DESIGN THINKING	8
BIODYNAMIC LIGHT	10
INSPIRATION	12
<hr/>	
LIGHTING	20
SMART LAMPS	22
ASYMMETRIC LAMPS	24
DOUBLE JOINT LAMPS	26
DESIGN LAMPS	30
FOLDABLE & MOBILE LAMPS	33
BATTERY LAMPS	35
TECHNICAL LAMPS	37
LIGHT THERAPY LAMPS	38
FLOOR LAMPS WITH INDIRECT LIGHTNING	40
FLOOR LAMPS WITH DIRECT AND INDIRECT LIGHTNING	44
<hr/>	
WORK PLACE ERGONOMICS	46
AXIO MONITOR ARMS	48
ERGONOMIC ACCESSORIES	56
HOME OFFICE DESK	60
DYNAMIC SEATS	61
FOOTRESTS	63
MONITOR & LAPTOP STANDS	65
<hr/>	
INTERIOR ACCESSORIES	66
CLOCKS	68
COAT STANDS	72
COAT PEGS	75
<hr/>	
ASSORTMENT OVERVIEW	78

OUR HISTORY

Founded in 1952, UNILUX is a **French company** specializing in lighting and ergonomics. Bringing DAYVIA, KOS Lighting and UNILUX together within a single business unit enables HAMELIN to consolidate its expertise, broaden its offering and strengthen its presence across Europe.

Our dynamic, committed team aims to **enhance everyone's well-being** by making your workspace harmonious and welcoming, aligned with **your expectations and those of your colleagues**.

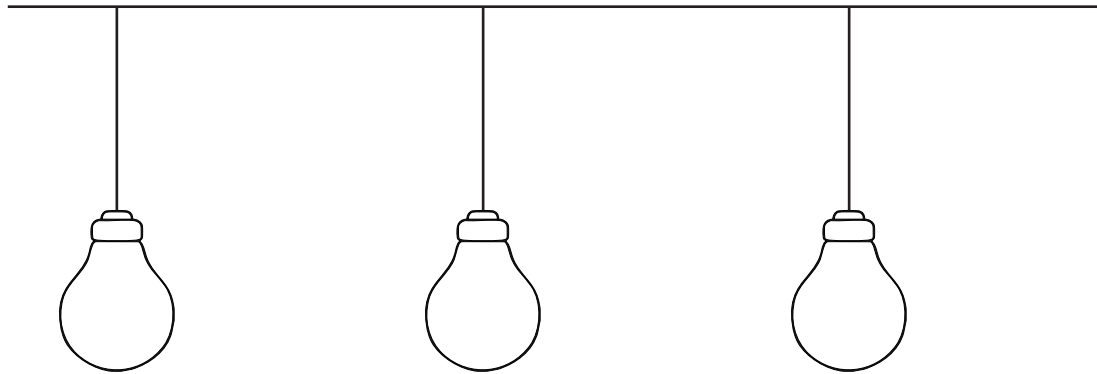

1952

French company founded in the southern suburbs of Paris as the exclusive distributor in France for **LEDU**, a Norwegian lighting brand.

1973

Over the past 25 years, **UNILUX** has become a benchmark in the lighting sector in France and across Europe.

2000

UNILUX joined the French group HAMELIN, the European leader in stationery. **UNILUX** won a RED DOT DESIGN AWARD with the INFINITY lamp.

INNOVATION & DESIGN
ECO-DESIGN
CUSTOM
DURABILITY
ETHICS

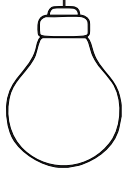

2016

UNILUX received ISO 1800 certification. The company evolved and modernized, becoming a creator of atmosphere and well-being.

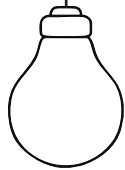

2020

Acquisition of **DAYVIA**, the French leader in light therapy. **UNILUX** expanded its expertise through the natural benefits of light on health.

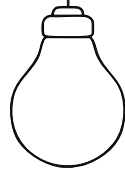

2021

Merger of **Kos Lighting** with **HAMELIN** : **UNILUX** strengthened its position with office fit-out specialists and interior designers.

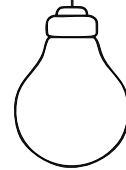

2022

Creation of **HAMELIN UNILUX** benefiting from the synergies between all the brands within the European HAMELIN Group.

OUR VALUES

Being **healthier and feeling better** is a philosophy that can be found in all areas of life – including the work environment. With innovative and effective products, **Unilux makes an important contribution** to greater health and well-being in the workplace.



ATTENTION

We value our brand, our team and our partner, as well as the relationships with our distributors and users.

We listen to everyone in order to constantly create new products and services. We strive to support our customers with their health and their well-being.



CREATIVITY

Innovation is at the heart of Unilux's DNA.

Our desire for permanent innovation is inspired by a “design thinking” approach and knowledge of consumer needs and working methods.

Our teams imagine and test products that will meet the needs of tomorrow for everyone in order to improve their daily well-being.



SINCERITY

We communicate complex concepts in a clear and accessible way for everyone with complete transparency.

This sincerity is present in each product from its creation to its marketing and development in order to meet the needs of our customers and the requirements of our brands.



DURABILITY

We are committed to a sustainable and responsible ethical charter.

We choose recycled/recyclable material. We develop eco designed products which are made to limit impact for the environment.

Hamelin lighting & ergonomics' aims to be always **responsible and committed**. Our products are designed to **improve the well-being and make workspaces harmonious and convivial**, in line with user expectations. Our aim is to preserve our planet for present and future generations.

OUR MISSION



Biodynamic lighting: source of well-being

- Improve your visual comfort
- Optimize your circadian cycle
- Promote your concentration



Ergonomics: innovative & adaptable

- Fight against the sedentary lifestyle by making your work space more dynamic
- Improve your well-being
- Increase your productivity



A harmonious & eco-friendly work space:

- Use recycled/recyclable materials
- Repairability & durability
- Reduced our carbon footprint by 15%

Unilux brings well-being and health to the workplace by using innovative and eco-friendly products to create an **ergonomic and harmonious workspace**.

OUR CSR APPROACH

Within the innovation approach, Unilux reconciles the needs of the user, technical feasibility and profitability by **integrating respect for the environment**.

The objective is to use the same raw materials and not to generate waste, so **our products will have a “circular” life** and will be renewable, recyclable and durable.

ECO-DESIGN THINKING

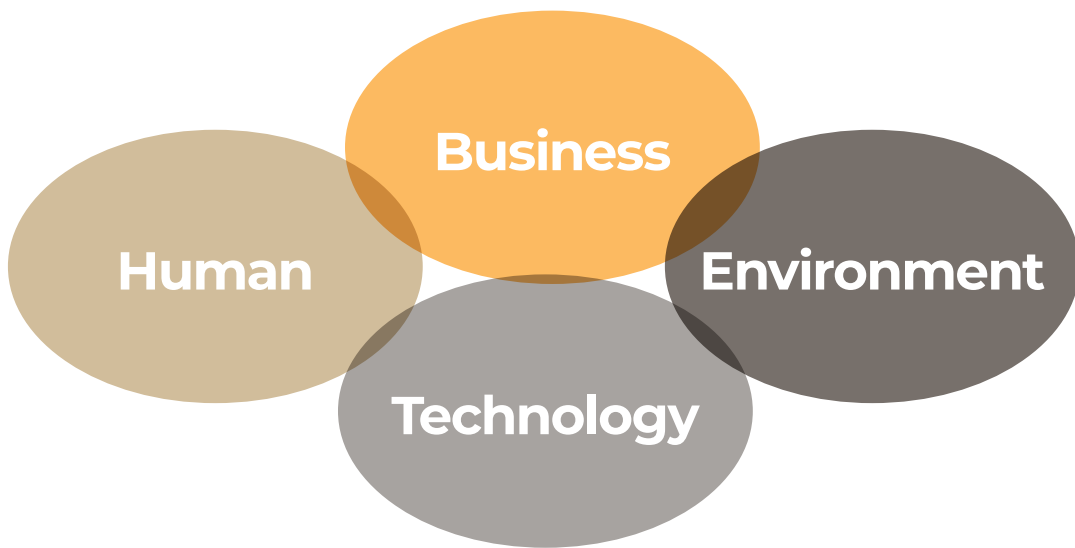

Our eco-responsible products

Preserving our natural resources is a priority. Due to this collective awareness Unilux has created in 2018, its first range based on wood from ecologically managed forests ranging from lighting to coat rack to clock. Since then Unilux uses natural and recycled materials to create environmentally friendly products.

As an actor in the lighting and office accessories sector, we energetically reduce the environmental impact of our products by reparability, durability, energy efficiency, recycling, end-of-life management and origin of raw materials.

Our certifications

Unilux is committed to an eco-responsible approach and to reducing its carbon impact. Indeed, the entire Unilux team is mobilized on environmental issues.

Sustainable development is at the heart of our strategy and our certifications prove our commitment.



Look for our FSC®-certified products!

When choosing a material, we look for the best compromise between **performance, durability and recyclability**. At Unilux, we take great care in selecting the best materials to provide you with high quality, durable products with a unique and refined design.

OUR MATERIALS



Recycled PP
100.000 marine animals die from getting entangled in plastic yearly.* Recycled end-of-life marine fibre waste such as used fishing nets, provides high-quality 100% recycled plastic in order to help preserve the oceans.

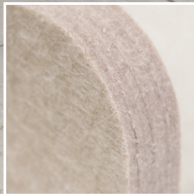

PET recycled
100 million marine animals die each year from plastic waste alone*. 100% of a PET bottle can be recycled over and over again. Converting postconsumer PET into a valuable resource helps the environment because rPET has a lower carbon footprint than virgin PET.

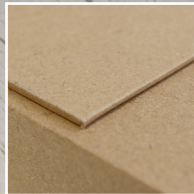

Carton recycled
The global consumption of paper and paperboard totaled 408 million tons in 2021. Consumption is projected to continue rising over the coming decade to reach 476 million tons by 2032.** Recycled paper and cardboard save resources and energy and preserves the environment.



Bamboo
Bamboo, known as green steel, is frequently used for its strength and abundance. It is a material that can absorb more CO2 than trees, but also releases more oxygen. Renewable and recyclable, bamboo products embody a natural and warm character.

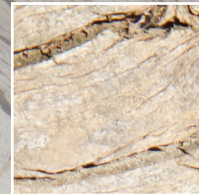

Wood
Wood is a material with many advantages. Natural and ecological, it is durable, efficient and effective. Many companies use it for its durability and nobility. We love wood for its living and unique aspect. The wood we use comes from forests managed in an eco responsible way.

*Source: <https://www.condorferries.co.uk>

**Source: Statista Research Department, Mar 24, 2023

BIODYNAMIC LIGHT

"Biodynamic light" is the acronym for Human Centric Lighting (HCL), which refers to LED (biodynamic) lighting that **puts people at the center of attention**. This type of lighting promotes a person's well-being and the proper functioning of their biological rhythm.

SOURCE OF WELL-BEING

Why adopt biodynamic light in your daily life?

Natural light evolves throughout the day and changes colour:

- **Sunrise: golden light**
- **Morning: white light**
- **Middle of the day: softer**
- **Sunset: yellow-orange light**

Light has a strong influence on our physical and mental behavior. It affects our concentration, our creativity and therefore our productivity. In the morning, the light is reinforced by the so-called "blue" light, which blocks the secretion of melatonin and has the effect of toning you up by boosting your concentration. Conversely, the melatonin secreted at sunset will make it easier for you to fall asleep because of the colour of the light, rich in red and orange.

Sleep disorders, mood disorders, headaches or eye strain can affect your professional life as well as your morale. In order to avoid these symptoms, the ideal is to live at the rhythm of the sun, but we spend nearly 8 hours sitting at our desk under artificial lighting.

This is why it is recommended to choose a type of lighting that suits you and your needs.

Adapting a biodynamic light that accompanies you on a daily basis will allow you to be more efficient in your projects, to be more dynamic and in a good mood. This is the reason why each individual must carefully follow his "circadian rhythm".

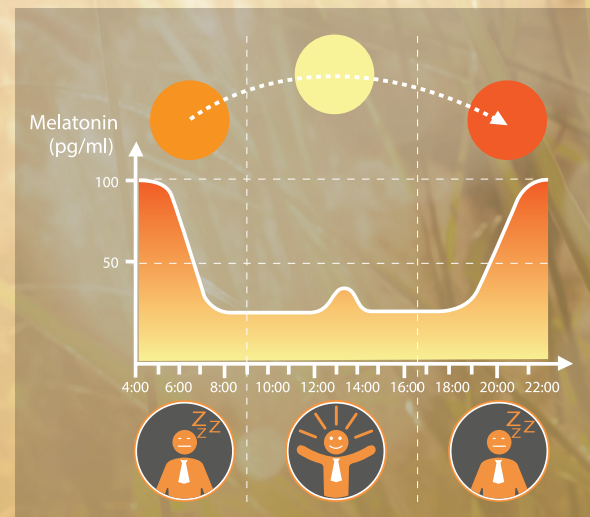



What is the circadian rhythm?

The circadian rhythm is a biological rhythm that affects a series of human physiological processes such as cognitive abilities, sleep/wake cycle, heart rate, mood, memory and body temperature). It is linked to the Earth's rotational movements, lasts about 24 hours and is regulated by light, which acts as a synchronizer.

Three factors influence the circadian rhythm:

- **The secretion of melatonin:** a sleep hormone, which must be secreted only at night.
- **Social life:** for people who work at night and therefore have a different circadian rhythm than natural sunlight.
- **Light:** it is important to respect the natural light cycle because humans are "programmed" to follow it.

Lack of exposure to natural light contributes to the disruption of the biological rhythm and has led to a decrease in daily sleep time of about 1 hour over the last 100 years.

On the other hand, we are in an era where we are monopolized by screens, whether in the evening or in the middle of the day; these very cold "blue" lights that disrupt our sleep are also disruptive elements of our biological clock. A desynchronized biological rhythm leads to sleep and mood disorders, poorer concentration and favors the appearance of seasonal depression. It is therefore important to respect natural light, to reproduce it as well as possible around us and to integrate it into our work environment.

OCEANIS

In 2022, Hamelin partnered with a Danish company that recycles end-of-life marine fiber waste such as used fishing nets through a unique and environmentally friendly technology.

From this 100% recycled and quality plastic, Unilux contributes to the preservation of the oceans and is part of the circular economy allowing by

- the reduction of the risk of plastic pollution in the seas
- the reduction of CO₂ emissions and
- the preservation of fossil resources.

The Unilux Oceanis range includes the JokerLED 2.0 lamp and the Chrysalis footrest. These two new products use this new material without compromising on quality and aesthetics.



1. Chrysalis footrest (p. 64)

2. JokerLED 2.0 desk lamp (p. 32)

AXIO

A new generation of monitor arms.

Much more than a simple monitor arm, the AXIO range offers an innovative solution that combines the prevention of musculoskeletal disorders with the benefits of biodynamic lighting. Its central mast — the true backbone of this monitor arm system — enhances both ergonomics and overall well-being.

Tailor-made customization.

Our sliding arm supports adapt seamlessly to all work environments, delivering both flexibility and ergonomic comfort to your workspace. AXIO offers a wide range of modular components, allowing you to create dynamic configurations tailored to the needs of every user.

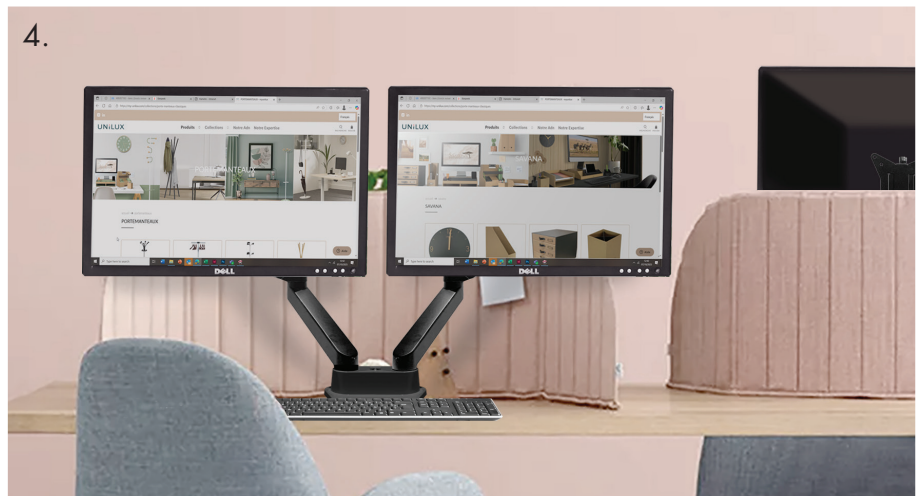
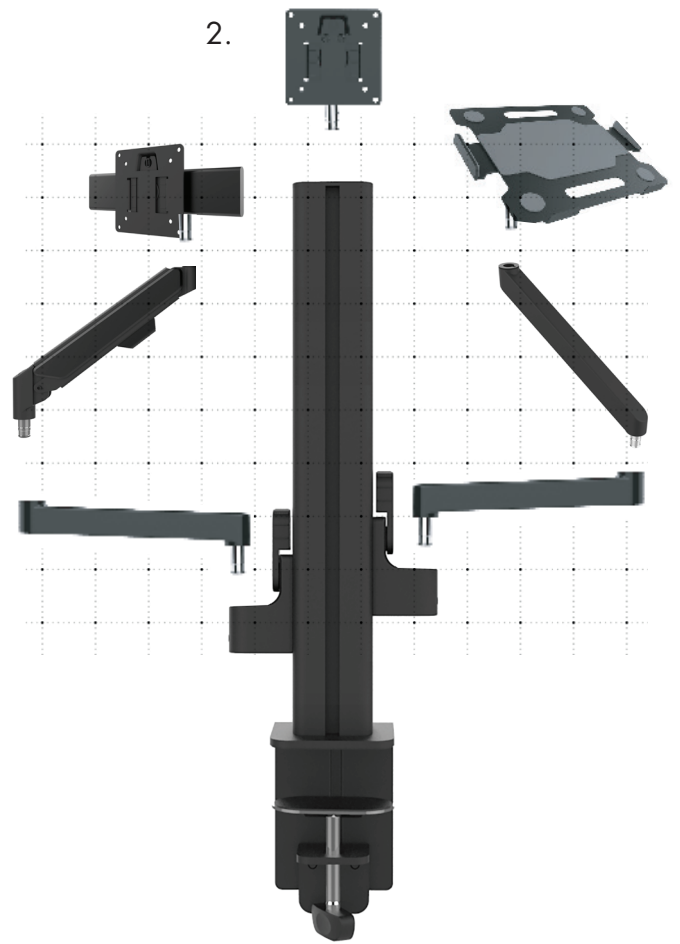

- 1. AXIO double mechanical arms (p. 50)
- 2. AXIO: Tailor-made customization (p. 50)
- 3. BUNDLE: Axio + Strata Lumino (p. 51)
- 4. KORO double gaz spring arm (p. 54)

BALIWEÏ

Thanks to its long fibers, bamboo is stronger and more durable than most woods. Elegant, renewable and from sustainably managed sources, this fast-growing natural material is ideal for designing aesthetic, long-lasting objects.

It is in this desire to design and offer products that are both stylish and eco-friendly that Unilux launched the Baliweï collection in 2020 using bamboo.

It is composed of a double arm architect lamp, a powerful floor lamp with 3 levels of tactile intensity variation, a 6 pegs coat rack equipped with an umbrella holder and a clock with its 100% bamboo tray with a silent movement that will be conducive to concentration in any workspace environment.



- 1. Bora Bamboo coat stand (p. 73)
- 2. Baly Bamboo Indirect uplighter (p. 42)
- 3. Baya Bamboo desk lamp (p. 28)
- 4. Palma Bamboo clock (p. 70)

SCÄNDINÄV

Looking for a simplicity in design with suits to every setting? Look no further, white and wood is the answer. This mix is very popular and the current trend. Clean lines are incorporated with understated elegance and warm functionality, which creates a very homely feel. Ideal for large interiors, such as a reception hall, as well as smaller contemporary spaces, like individual offices.

The Unilux Scändinäv range with its pure design will give character to workspaces at home or in the office. Pryska, Access, Baltic, Vicky and Aurora are the scandi-look inspired products within this range.



- 1./2. Aurora coat pegs (p. 75)
- 3. Baltic clock (p. 71)
- 4. Aurora coat stand (p. 73)
- 5. Vicky desk lamp (p. 32)



DESK LAMPS

Desk lamps are more than just light sources; they are functional companions that illuminate tasks and enhance the ambiance of the workplace. With designs ranging from sleek and modern to classic and ornate, these compact lights serve as both practical tools and stylish accents, transforming any desk into a well-lit place of productivity and creativity.

SMART LAMPS	22
ASYMMETRIC LAMPS	24
DOUBLE JOINT LAMPS	26
DESIGN LAMPS	30
FOLDABLE & MOBILE LAMPS	33
BATTERY LAMPS	35
TECHNICAL LAMPS	37

LIGHT THERAPY LAMPS

Light therapy lamps can alleviate ailments ranging from seasonal disruption to sleep disturbances and mood swings. By mimicking natural sunlight, these lamps offer a non-invasive and convenient way to regulate circadian rhythms, elevate mood and restore well-being, especially in the darker months or in environments with limited sunlight.

LIGHT THERAPY LAMPS	38
---------------------	----

UPLIGHTER

Uplighter illuminate rooms with a touch of elegance and ingenuity. They are designed in such a way that they direct the light upwards and emit a soft and diffuse glow that gently emphasizes the ambiance of the room. With their ability to create a harmonious interplay of light and shadow, they provide an they offer an artistic and at the same time functional for any interior.

WITH INDIRECT LIGHTING	40
WITH DIRECT & INDIRECT LIGHTING	44

Features



ON/OFF



Colour temperature adjustable



Wireless charger



Intensity dimming



Light sensor



USB port



Tactile intensity variation



Asymmetric lighting



Replaceable by the end user



Rechargeable battery



"My Unilux" application



Replaceable by a professional

SMART LAMPS

Biodynamic lighting: source of well-being!

Light acts on the phases of wakefulness and sleep, thus maintaining the circadian rhythm. The active phase starts as soon as the day rises and the rest phase as soon as the night falls. Lighting therefore plays a key role in improving concentration, creativity and performance, particularly through the regulation of melatonin (the hormone that causes sleep). 480 nanometers is precisely the range at which the light perceived by the receptors of the human eye lowers the level of melatonin and the person benefits from the stimulating and soothing effects of the light.

It is in this approach called "human centric lighting", that Unilux has designed its range of app driven lamps (SUNLIGHT, EYELIGHT and TIMELIGHT) which reproduce a lighting close to natural light. They automatically control the colour temperature throughout the day by programming 3 essential stages of a working day: arrival at work, lunch break and end of the day. These exceptional lamps provide the right quality of light at each moment of the day.

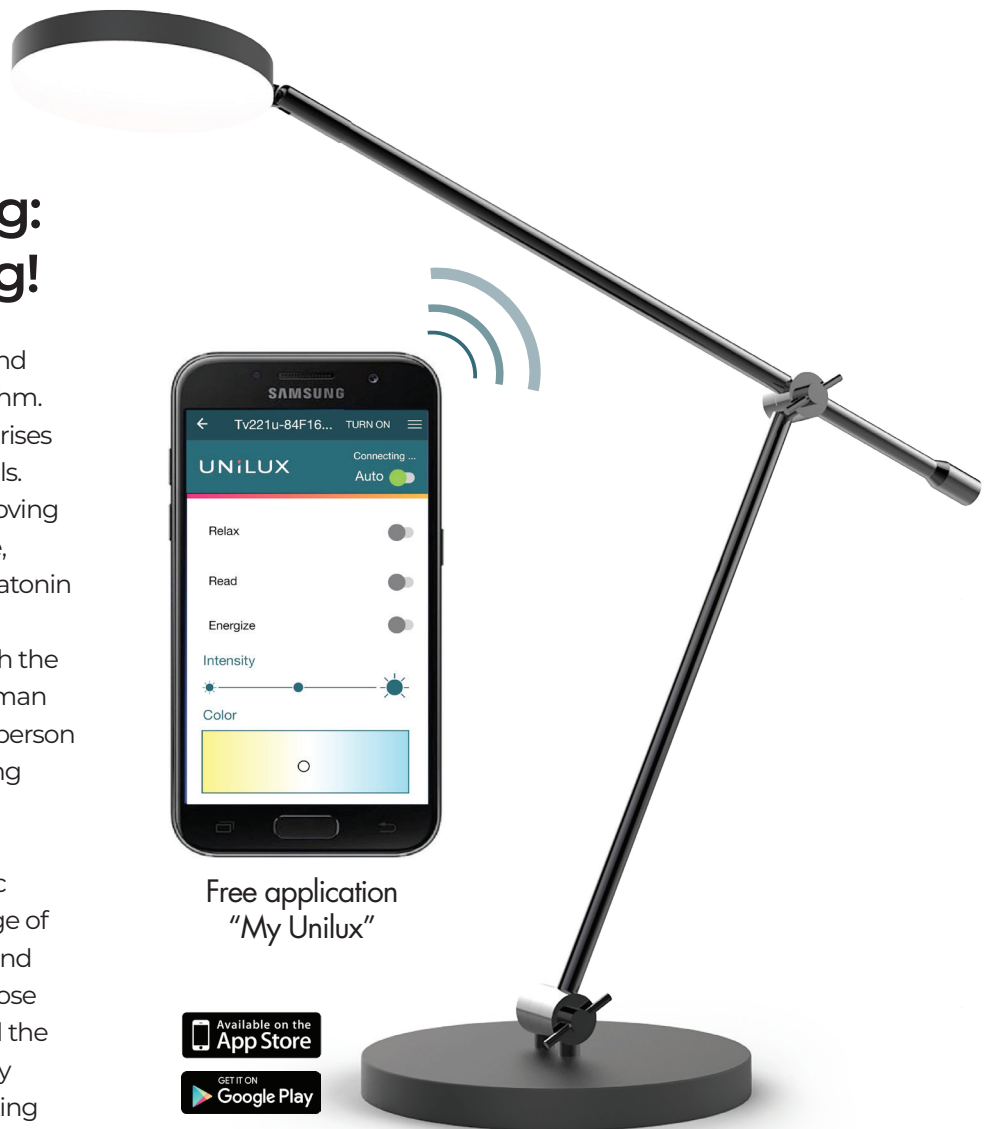

Free application
"My Unilux"



SUNLIGHT

Source's lifetime: 50.000 h
Lux at 35 cm: 1.450
Material: aluminium, plastic
2 years warranty



Black 400 110 128

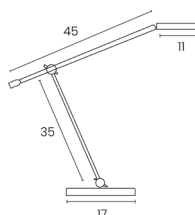

546
lumen (lm)

7
W

78
lm/W

86
CRI

2.700 K
5.200 K

SUNLIGHT automatically synchronizes the circadian rhythm and contributes to well-being. It works with the «my Unilux» application which also allows to manually control the colour temperature and light intensity. It switches off and on automatically.





ASYMMETRIC LAMPS

STRATA 80

Source's lifetime: 50.000 h
Lux at 40 cm: 2.400
Material: Aluminium / steel / silicon
2 years warranty



Black 400 199 208

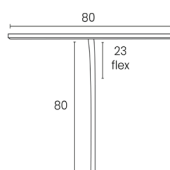
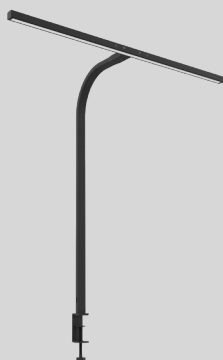

2.046 lumen (lm)

19 W

108 lm/W

85 CRI

3.000 K
4.000 K
5.000 K
6.500 K

Multi-screen workstation designed for a 4-screen setup. Asymmetrical lighting for glare-free visual comfort. Precise adjustment of brightness and color temperature. Integrated light sensor for automatic adaptation.



STRATA BASE

Source's lifetime: 35.000 h
Lux at 40 cm: 2.200
Material: Aluminium / steel / silicon
2 years warranty



Black 400 188 448
White 400 188 446



2.235 lumen (lm)

18 W

126 lm/W

87 CRI

2.800/3.500/
4.500/5.000/
6.300 K

Offers quality lighting with a large 66 cm diffuser, limiting glare. Touch-sensitive keypad allows you to adjust brightness and color. Wireless remote control offers convenient control – first model on the market in Europe. USB port to charge your smartphone. Memory function for light intensity and color temperature. 4 TIMER functions – save energy.



ELITE LUMINO

Source's lifetime: 50.000 h
Lux at 40 cm: 3.672
Material: Aluminium recycled/steel/ABS
2 years warranty



Black 400 202 310

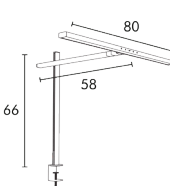

2.993 lumen (lm)

24 W

108 lm/W

84 CRI

3.000 K
4.000 K
5.000 K
6.500 K

Combines elegant design with advanced features: it offers customizable, glare-free lighting thanks to its rotating arm and asymmetrical light distribution. Color temperature adjustment: customize the lighting to suit your needs – whether you're relaxing, reading, or working. Sleek, airy design and uniform light. Mounted with a clamp, this lamp saves desk space and fits easily behind your computer.



STRATA LUMINO

Source's lifetime: 50.000 h
Lux at 40 cm: 3.672
Material: Aluminium / steel / silicon
2 years warranty



Black 400 207 194

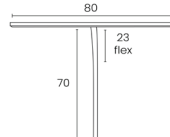
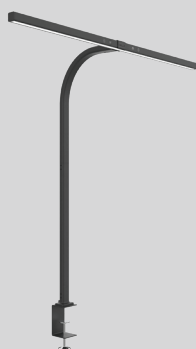

2.993 lumen (lm)

24 W

108 lm/W

84 CRI

3.000 K
4.000 K
5.000 K
6.500 K

Asymmetrical lighting that significantly reduces glare and optimizes illumination of targeted areas. Light therapy mode – promotes well-being and vitality throughout the day, helping to alleviate depressive states, including seasonal affective disorder caused by lack of sunlight. Color temperature adjustment: customize the lighting to suit your needs whether you're relaxing, reading, or working. Mounted with a clamp, this lamp saves desk space and fits easily behind your computer.



Asymmetrical lighting: reduces eye fatigue!

A desk lamp with symmetrical lighting distributes the light evenly over the work surface. This is a huge benefits, especially for larger surfaces.

So, when the eye moves from a brightly lit area to a dark one, the pupil will contract and then dilate and this will cause eye strain that can result in tingling eyes and headaches. To prevent these problems, an asymmetrical lamp is beneficial. It allows the light to be directed with the help of internal reflectors in order to shift the light and illuminate a larger surface. This allows to illuminate the keyboard and work documents in front of the screen without causing reflections or unpleasant glare on the screen while limiting the light contrast that causes eye fatigue.

Symmetrical lighting:

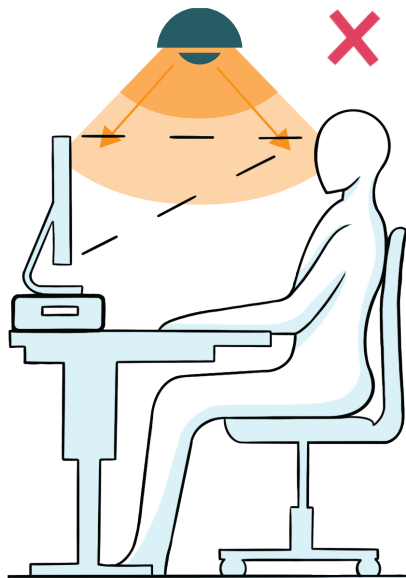

Asymmetrical lighting:

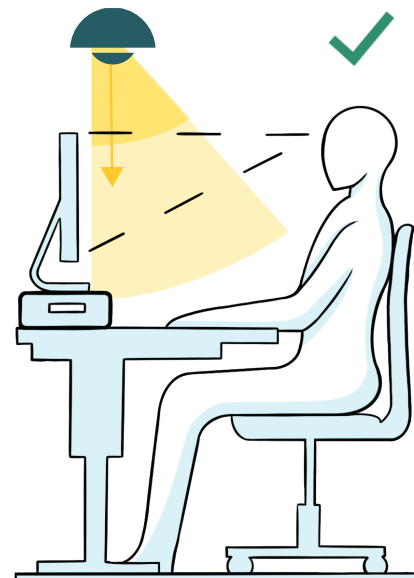

STRATA

Source's lifetime: 50.000 h
Lux at 40 cm: 2.400
Material: aluminium, ABS
2 years warranty



Black 400 124 562
White 400 165 231

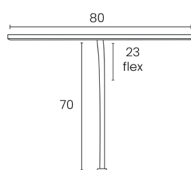

2.046 lumen (lm)

19 W

108 lm/W

85 CRI

3.000 K
4.000 K
5.000 K
6.500 K

STRATA stands out with its long lighting head (80 cm) allowing to light a large surface. It is ideally positioned behind computer screens. Its arm is partly flexible, making it easy to position the head. It is equipped with many features located on the head: touch switch, external light sensor (adapts the light according to the external contribution), variation of intensity and colour temperature.



VISILIGHT

Source's lifetime: 30.000 h
Lux at 35 cm: 480
Material: aluminium, ABS
2 years warranty



Black 400 153 723

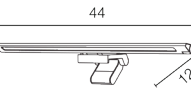

145 lumen (lm)

6 W

24 lm/W

>83 CRI

3.000 K
3.700 K
4.800 K

VISILIGHT is the essential lamp for travelling and/or telecommuting. Lightweight, it is easily installed on the computer screen thanks to its clip. It offers a quality lighting through its excellent diffuser which emits an asymmetrical lighting to prevent any glare. Its intensity and colour temperature variations allow to create the desired atmosphere on the work surface. Can be connected with a USB port.



TRAVELIGHT

Source's lifetime: 30.000 h
Lux at 35 cm: 550
Material: aluminium, ABS
2 years warranty



Black 400 140 802

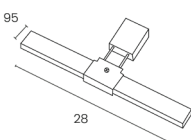

285 lumen (lm)

3 W

95 lm/W

83 CRI

3.000 K
4.000 K
5.200 K

TRAVELIGHT will be quickly indispensable during travelling. Lightweight and easy to install: clips onto the computer screen (0.5 to 3 cm thick). Intelligent (variation of intensity and colour temperature). It offers asymmetrical lighting and adapts its light for optimal visual comfort. Connects to a USB port. Carrying case and 5V/1A USB cable included.



DOUBLE JOINTED LAMPS

BAYA BAMBOO



Improve your visual comfort!

Poor lighting quality is one of the sources of discomfort cited by employees. Occupational medicine recommends a minimum of 500 Lux on the work surface according to the NF EN 12-464-1* standard. However, 300 Lux are emitted by ceiling lights in offices and only 34% of the offices reach the 500 Lux lighting level prescribed by the occupational medicine.

Unwanted blinking is generally due to insufficient illumination of your workstation and a poor orientation of the light flow leading to visual disorders. The double arm lamps or „architects“ allow to adjust the light where you want thanks to the great amplitude and flexibility of their double arm. They bring the necessary light complement and provide an excellent diffusion of light on your desk while taking care of your eyes.

* NF EN 12 464-1 (European standard): Requirements for lighting of indoor workplaces

<p>LUMILIGHT</p> <p>Source's lifetime: 25.000 h Lux at 35 cm: 2.300 Material: recycled aluminium 2 years warranty</p>  <p>Black 400 177 869</p>			<p>1.120 lumen (lm)</p> <p>8 W</p> <p>140 lm/W</p> <p>80 CRI</p> <p>3.000 K 6.000 K</p>	<p>The LUMILIGHT desk lamp is a new generation of ergonomic lamp with an innovative design. It offers a wide range of motion thanks to its double joints and provides quality lighting thanks to its large, slender head and textured diffuser. The two touch switches allow to dim the light and adjust the colour temperature continuously.</p> 
<p>PURELINE</p> <p>Source's lifetime: 35.000 h Lux at 35 cm: 2.280 Material: ABS, steel 2 years warranty</p>  <p>Metal grey 400 172 851 White 400 165 091</p>			<p>1.357 lumen (lm)</p> <p>13 W</p> <p>104 lm/W</p> <p>97 CRI</p> <p>3.300 K 4.200 K 5.800 K</p>	<p>PURELINE is distinguished by its slim, clean design. Its head is only 2 cm thick, which gives it an elegant character. Depending on the ambient light of workspace, the lamp adapts its lighting for better visual comfort, thanks to its brightness sensor. Its EYE CARING system will better protect your vision, reducing eye fatigue. 180° rotating head and 150° adjustable arm</p> 
<p>SWINGO LED</p> <p>Source life: 50.000 h Lux at 35 cm: 1.710 Materials: ABS and painted steel 2 years warranty</p>  <p>Black 400 093 838 White 400 093 839</p>			<p>1.249 lumen (lm)</p> <p>10 W</p> <p>125 lm/W</p> <p>84 CRI</p> <p>3.000 K</p>	<p>SWINGO LED is an ergonomic desk lamp with great fluidity and amplitude of movement thanks to its double arm fitted with compensation springs. The head remains parallel to the work surface whatever the arm movements. Easily accessible touch-sensitive dimmer switch on the head: 3 levels of light intensity. Supplied with a 2.3kg weighted base and a clamp with a maximum spacing of 55mm.</p> 
<p>SENZA 2.0</p> <p>Source's lifetime: 50.000 h Lux at 35 cm: 1.140 Material: ABS, aluminium, metal 2 years warranty</p>  <p>Metal grey 400 092 054</p>			<p>704 lumen (lm)</p> <p>7 W</p> <p>101 lm/W</p> <p>80 CRI</p> <p>3.000 K 4.500 K 6.500 K</p>	<p>SENZA 2.0 is a lamp with pure and original lines. Great amplitude of adjustment thanks to its double arm triple joint equipped with springs. It pivots on the base and its head can be oriented in all directions. The 2 tactile switches on the head allow you to vary the light intensity (3 intensities) and the colour temperature (3 temperatures) adapted to different activities.</p> 

LED LAMPS

MAMBOLED

Source's lifetime: 40.000 h
Lux at 35 cm: 1.235
Material: ABS, steel
2 years warranty



■ Metal grey 400 033 684
■ Black 400 033 683

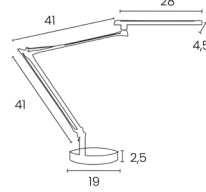

665
lumen (lm)

7
W

95
lm/W

84
CRI

2.900 K

MAMBOLED is a lamp equipped with compensation springs allowing movements of a great amplitude and flexibility. Swivels on its base. Head can be oriented in all directions. Equipped with an anti-glare diffuser for better light distribution on the work surface. Excellent quality/price ratio. Very good luminous efficiency. ON/OFF switch on the head. Delivered with a clamp and a base.



MAMBOLED 2.0

Source's lifetime: 40.000 h
Lux at 35 cm: 900
Material: ABS, aluminium, steel
2 years warranty



■ Metal grey 400 140 847
■ Black 400 140 801

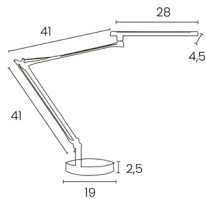

680
lumen (lm)

7
W

97
lm/W

83
CRI

3.000 K
4.000 K
5.000 K

MAMBOLED 2.0 is another version of the MAMBOLED with intensity and temperature control. It is supplied with a 1.6 kg base and a clamp (maximum distance of 4cm). Touch switch on the head: 4 light levels and 3 colour temperatures.



SUCCESS 66/80 CM CLAMP + BASE

Supplied without bulb. (E27)
Material: ABS, aluminium, steel
2 years warranty

■ Black 66 cm 400 093 600
■ Black 80 cm 400 093 579

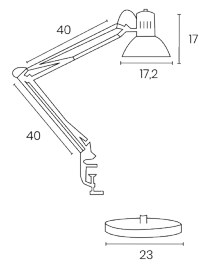

supplied
without
bulb



E27

SUCCESS 66/80 is an architect lamp with a universal design. Double articulated and pivoting arms and adjustable head. ON/OFF switch located on the cord.



SUCCESS 80 CM CLAMP + BASE

Source's lifetime: 30.000 h
Lux at 35 cm: 1.640
Material: aluminium, metal
2 years warranty



■ Chrome 400 092 123

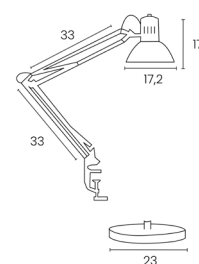

915
lumen (lm)

11
W

83
lm/W

84
CRI

3.000 K

SUCCESS 80 is an architect lamp with a universal design. Double articulated and swivelling arms and adjustable head. Its lower arm equipped with three metal tubes ensures a great robustness. Great visual comfort and good light distribution. ON/OFF switch located on the head.



BAYA BAMBOO

Source's lifetime: 30.000 h
Lux at 35 cm: 1.640
Material: steel, aluminium, bamboo
2 years warranty



■ White/bamboo 400 153 645
■ Black/bamboo 400 140 800

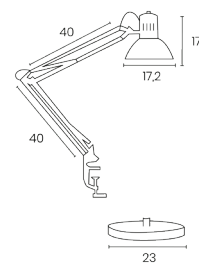

915
lumen (lm)

11
W

83
lm/W

84
CRI

3.000 K

BAYA BAMBOO is a revisited architect lamp with a natural bamboo decoration (grass). Switch on the cord. Delivered with a 3 kg base and a clamp.



VENUSLIGHT

Source's lifetime: 50.000 h
Lux at 35 cm: 4.700
Material: ABS, metal
2 years warranty



White 400 165 033

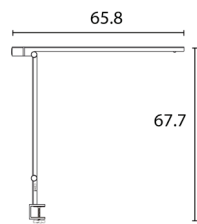

1.720 lumen (lm)
17 W
101 lm/W
93 CRI
2.700 K to 5.000K

A new generation of ergonomic desk lamp that offers a wide range of movement for quality lighting thanks to its large, long head and innovative design. Thanks to its 2 joints VENUSLIGHT can be used in a wide range of positions. Depending on the ambient light in the workspace the lamp adapts its lighting and is equipped with a motion sensor.



SWINGOLED 2.0

Source's lifetime: 35.000 h
Lux at 35 cm: 1.820
Material: ABS, aluminium, steel
2 years warranty



Black 400 190 981

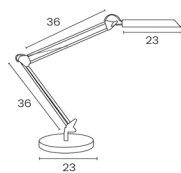

1.450 lumen (lm)
13 W
111 lm/W
95 CRI
3.000 K 4.000 K 5.500 K

5 brightness levels with adjustable color temperature. Dual tilting arms with a rotating, adjustable head. Versatile design with weighted base or clamp (opening up to 5.5 cm).



ZENITH

Source's lifetime: 30.000 h
Lux at 35 cm: 2.090
Material: Aluminium recycled / steel
2 years warranty



Black 400 188 588

Metal Grey 400 188 589



2.370 lumen (lm)
11 W
113 lm/W
82 CRI
3.000/3.500/ 4.000/4.200/ 5.000 K

Innovative arm combining rotation and sliding for precise positioning. Adjustable brightness and color temperature to suit your needs. 60-minute timer with automatic shut-off for added comfort and energy savings.



OMEGA

Source's lifetime: 30.000 h
Lux at 35 cm: 2.552
Material: ABS / aluminium recycled
2 years warranty



White 400 202 316

Black 400 202 315

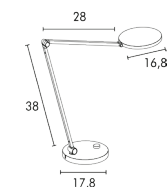

1.976 lumen (lm)
12 W
166 lm/W
94 CRI
4.000 K

Adjustable brightness for optimal visual comfort (CRI 94). 360° rotating head with tilting and rotating arms for precise lighting. Weighted base ensuring excellent stability.



DESIGN LAMPS



SOL

Bringing Design to the workspace!

On a desk, lamps are not only used to bring light. They are also decorative objects and, like any other piece of furniture, must be integrated with style into the design of an office space.

Our carefully finished lamps use quality materials such as metal, wood or glass and offer optimal lighting. Our designers are always looking to create the best combination of aesthetics and functionality.

TAMY

Source's lifetime: 20.000 h
Lux at 35 cm: 840
Material: ABS, metal, rubber
2 years warranty



- Black 400 172 506
- White 400 165 012
- Blue 400 165 017
- Pink 400 165 018
- Green 400 165 015
- Grey 400 165 986

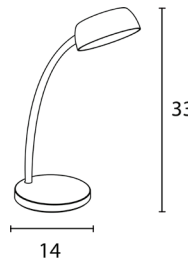

625 lumen (lm)
6 W
104 lm/W
84 CRI
3.000 K

TAMY has flexible arms and can be rotated 360°. Although it is quite light, it offers excellent stability. The head shape offers a wide diffusion of light on the workspace. It is available in 6 colours.



SOL

Source's lifetime: 20.000 h
Lux at 35 cm: 1.135
Material: ABS, metal, rubber
2 years warranty



- Black 400 077 402
- White 400 077 404
- Blue 400 077 405
- Red 400 077 406

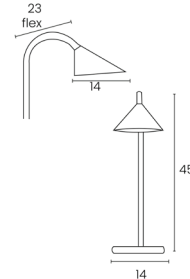

625 lumen (lm)
6 W
104 lm/W
84 CRI
3.000 K

SOL is a lamp equipped with a flexible arm that allows the head to be easily oriented in all directions. Its timeless design combines sobriety and modernity: the shape of the head favors the optimal diffusion of light on the work surface. Available in 4 colours.



EASY

Source's lifetime: 50.000 h
Lux at 35 cm: 1.465
Material: ABS, metal, rubber
2 years warranty



- Black 400 093 833

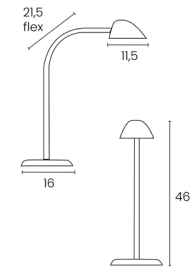

997 lumen (lm)
9 W
111 lm/W
84 CRI
2.900 K

EASY is a simple and efficient lamp for everyday use. It offers 3 levels of light intensity allowing to adapt the lighting throughout the day. Tactile switch located on the base. Equipped with a USB port (5 volts 1 amp) allowing the recharge of smartphones and other connected accessories via a USB cable (not included).



RUMBALED

Source's lifetime: 50.000 h
Lux at 35 cm: 1.060
Material: ABS, metal
2 years warranty



- Black 400 093 720

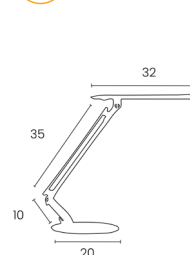







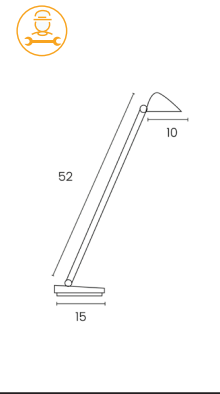

391 lumen (lm)
5 W
78 lm/W
84 CRI
3.600 K

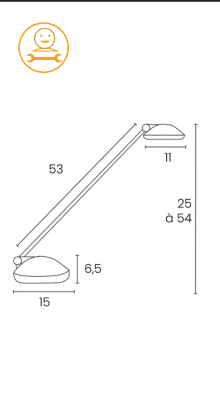
RUMBALED is a lamp with a slim head and an elongated shape that allows the light to be diffused widely on the work surface. Easy to access ON/OFF switch is located on the head. Thanks to its metal base, RUMBALED is a resistant and stable product.

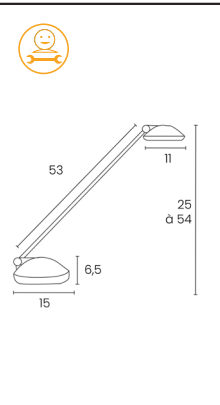

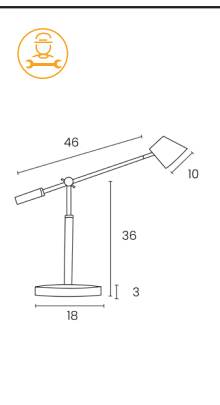
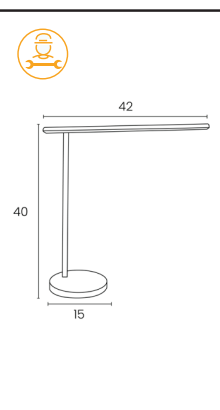
LED LAMPS

<p>JACK</p> <p>Source's lifetime: 40.000 h Lux at 35 cm: 925 Material: ABS, aluminium 2 years warranty</p> <p>A ↑ G E</p> <p>Black 400 077 430</p>			<p>488 lumen (lm)</p> <p>5 W</p> <p>98 lm/W</p> <p>>82 CRI</p> <p>2.900 K 3.400 K 4.000 K</p>	<p>The smart lamp JACK is equipped with a USB port (5 V, 1 A), ideally to recharge smartphones. It offers a tiltable arm and head, as well as 4 intensity and 3 colour temperature levels.</p> 
<p>JOKERLED</p> <p>Source's lifetime: 40.000 h Lux at 35 cm: 1.760 Material: ABS, aluminium 2 years warranty</p> <p>A ↑ G G</p> <p>Black 400 064 432</p>			<p>478 lumen (lm)</p> <p>6 W</p> <p>80 lm/W</p> <p>92 CRI</p> <p>3.000 K</p>	<p>The JOKERLED is one of the bestseller lamps with its modern design. It offers a tiltable head and arm and a great visual comfort. The LED module can be changed easily, when necessary.</p> 
<p>JOKERLED BLUE</p> <p>Source's lifetime: 40.000 h Lux at 35 cm: 1.760 Material: recycled PP and ABS 2 years warranty</p> <p>A ↑ G G</p> <p>Blue oceanis 400 179 658</p>			<p>478 lumen (lm)</p> <p>6 W</p> <p>80 lm/W</p> <p>92 CRI</p> <p>3.000 K</p>	<p>The OCEANIS JOKERLED in blue is the eco-responsible version of the classis JokerLed. The shells of the head and the base are made of 100% recycled PP from recycled and used fishing nets. It offers a great visual comfort. The LED module can be changed easily.</p> 
<p>VICKY</p> <p>Source's lifetime: 50.000 h Lux at 35 cm: 1.870 Material: rmetal, wood 2 years warranty</p> <p>A ↑ G E</p> <p>White/beech 400 110 084 Black/beech 400 153 732</p>			<p>997 lumen (lm)</p> <p>9 W</p> <p>111 lm/W</p> <p>84 CRI</p> <p>2.900 K</p>	<p>VICKY is a lamp mixing white and warmth of wood. It offers three levels of light intensity thanks to its switch positioned on the base. It is equipped with a USB-C port (5 V, 1 A) for quick charging of a smart-phone or tablet.</p> 
<p>DIVA</p> <p>Source's lifetime: 30.000 h Lux at 35 cm: 1.150 Material: ABS, aluminium 2 years warranty</p> <p>A ↑ G E</p> <p>Black 400 124 560</p>			<p>745 lumen (lm)</p> <p>7 W</p> <p>106 lm/W</p> <p>>82 CRI</p> <p>3.000 K 4.200 K 6.700 K</p>	<p>DIVA is a lamp with a pure design and multiple functions. Touch switch on the base: 4 levels of light intensity and 3 levels of colour temperature. It is equipped with a USB port ((5 V, 1 A) and a Qi charger.</p> 

FOLDABLE & MOBILE LAMPS



LINKA

NOVY LED

Source's lifetime: 30.000 h
 Lux at 30 cm: 970
 Material: Aluminium recycled / ABS
 2 years warranty



Black 400 188 811

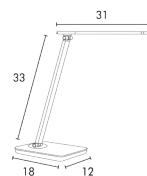

905
lumen (lm)

5
W

90
lm/W

83
CRI

3.000/3.500/
4.000/5.000/
6.000 K

2 USB-C ports to easily charge your devices.
Adjustable brightness and color temperature to suit your needs.
Rotating head and tilting arm for precise lighting.



LINKA

Source's lifetime: 50.000 h
 Lux at 35 cm: 1.695
 Material: aluminium, ABS
 2 years warranty



Black 400 124 484

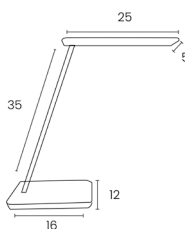

515
lumen (lm)

5
W

103
lm/W

84
CRI







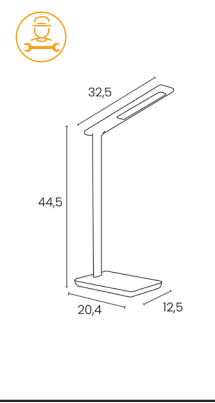

3.000 K
3.800 K
5.000 K
6.900 K

The small lamp LINKA in pure design offers multiple functions. It offers a 4 colour temperature and 4 intensity levels as well as a touch switch on the base. A very nice feature is the USB port (5 V, 1 A) and a Qi-charger.

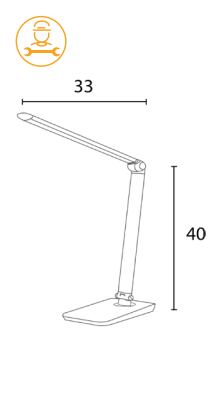

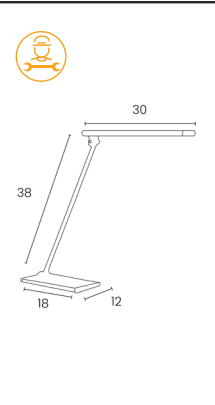
Saving space at the workspace

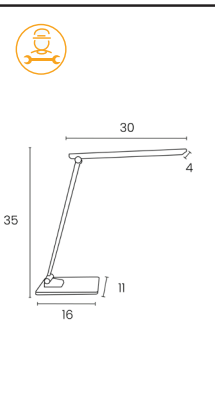
Nowadays, many companies are confronted with a problem of space in their workspaces and many of their employees lack space on their desks. With this in mind, and in order to optimise the workspace, foldable lamps take up a minimum of space on the desk and can be stored in any storage space (drawer, shelf, etc.) once they have been switched off.

<p>JAZZ</p> <p>Source's lifetime: 50.000 h Lux at 35 cm: 1.160 Material: ABS, aluminium 2 years warranty</p> <p>A ↑ G G</p> <p>White/metal grey 400 093 836</p>			<p>977 lumen (lm)</p> <p>13 W</p> <p>75 lm/W</p> <p>82 CRI</p> <p>2.800 K 3.800 K 4.900 K</p>	<p>JAZZ is distinguished by a design with fine and pure lines. Its head is only 1 cm thick.</p> <p>Multifunctional touch switch on the base with 4 levels of light intensity + night light, also allows the adjustment of the colour temperature 3 positions. Equipped with a USB port (5 V, 1 A) and a wireless phone charger (Qi certified).</p> 
<p>TWISTLED</p> <p>Source's lifetime: 50.000 h Lux at 35 cm: 1.120 Material: ABS, aluminium 2 years warranty</p> <p>A ↑ G E</p> <p>Black 400 165 037</p>			<p>1.558 lumen (lm)</p> <p>14 W</p> <p>111 lm/W</p> <p>86 CRI</p> <p>2.700 K to 6.000 K</p>	<p>TWISTLED is distinguished by its slim and clean design, which gives it an elegant character. With its +/- 180° rotating head, its 150° adjustable arm and its +/- 170° rotating base (right and left). Equipped with a USB-C charging port (5 volts, max 1 A) – charge your smartphone or tablet (cable not included).</p> 
<p>TERRA</p> <p>Source's lifetime: 40.000 h Lux at 35 cm: 1.145 Material: aluminium 2 years warranty</p> <p>A ↑ G F</p> <p>Metal grey 400 077 409</p>			<p>680 lumen (lm)</p> <p>7 W</p> <p>97 lm/W</p> <p>83 CRI</p> <p>3.500 K</p>	<p>TERRA is a modern lamp with slim, clean lines. Extra-flat head and base. Economical and functional, it has 4 light intensities and offers optimal visual comfort. Swivel and tilt arm and head. Tactile switch on the base allows to choose its light intensity among.</p> 
<p>POPY</p> <p>Source's lifetime: 50.000 h Lux at 35 cm: 1.100 Material: aluminium, glass 2 years warranty</p> <p>A ↑ G F</p> <p>White 400 124 478 Black 400 153 693</p>			<p>408 lumen (lm)</p> <p>5 W</p> <p>82 lm/W</p> <p>>84 CRI</p> <p>3.000 K 4.500 K 7.000 K</p>	<p>POPY is a lamp that combines noble materials: aluminum and glass and a technical lighting.</p> <p>A short pressure on the base allows you to choose the colour temperature and a long pressure will adjust the intensity of the lighting. In addition to its classic driver, POPY can also be connected directly to a USB port (cable provided).</p> 

LAMPS ON BATTERY



NELLY

NELLY

Source's lifetime: 20.000 h
 Lux at 35 cm: 1.100
 Material: ABS, rubber, metal
 2 years warranty



White 400 124 483

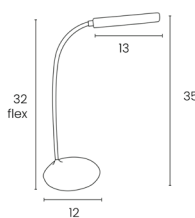

369
lumen (lm)

3
W

123
lm/W

86
CRI

2.900 K
4.100 K
6.300 K

NELLY is a wireless lamp that accompanies you everywhere. It can also be plugged into the USB port of a computer.

Its flexible arm surrounded by silicone will allow you to direct the light according to your needs.

The switch / dimmer will allow you to choose the colour temperature among the 3 proposed and to adjust the desired level of light.



GALY 1800

Source's lifetime: 50.000 h
 Lux at 35 cm: 500
 Material: ABS, metal, rubber
 2 years warranty



White 400 132 274

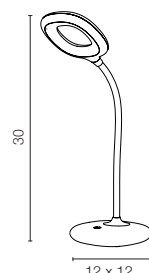

418
lumen (lm)

3
W

139
lm/W







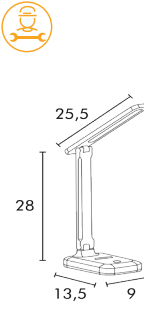

80
CRI

4.100K

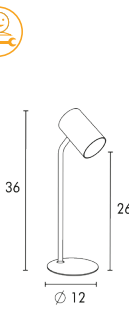
GALY 1800 is a nomadic lamp designed to accompany you on your travels: light and easily foldable thanks to its fully flexible arm, it has an autonomy of 3 hours. For your visual comfort, this lamp is equipped with a dimmer and LEDs protected by an opaque plastic to prevent glare.

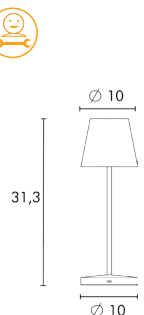

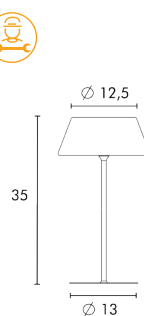
LED LAMPS

<p>KAPA</p> <p>Source's lifetime: 50.000 h Lux at 28 cm: 550 Material: ABS 2 years warranty</p> <p>A ↑ G E</p> <p>White 400 188 497</p>		 <p>25,5 28 13,5 9</p>	<p>222 lumen (lm)</p> <p>2 W</p> <p>183 lm/W</p> <p>89 CRI</p> <p>3.000 K 4.500 K 6.000 K</p>	<p>Self-powered thanks to its compact rechargeable battery. Adjustable color temperature and 3 brightness levels. Laptop-compatible, powered directly via USB. Charging time 3 hours. Battery: 800 mAh.</p> 
<p>KATZ</p> <p>Source's lifetime: 50.000 h Lux at 26 cm: 800 Material: ABS, steel 2 years warranty</p> <p>A ↑ G E</p> <p>Black 400 188 806</p>		 <p>36 26 Ø 12</p>	<p>208 lumen (lm)</p> <p>2 W</p> <p>105 lm/W</p> <p>89 CRI</p> <p>3.000 K 4.500 K 6.000 K</p>	<p>Touch control for adjusting brightness and color temperature. Rotating head to direct light with precision. Practical format, ideal for students.</p> 
<p>AVA</p> <p>Source's lifetime: 50.000 h Lux at 23 cm: 1.400 Material: Steel / ABS 2 years warranty</p> <p>A ↑ G D</p> <p>Black 400 190 955 Light Green 400 190 958 Brick 400 190 959 Orange 400 190 980</p>		 <p>Ø 10 31,3 Ø 10</p>	<p>307 lumen (lm)</p> <p>8 W</p> <p>142 lm/W</p> <p>91 CRI</p> <p>3.000 K</p>	<p>Versatile design, suitable for both indoor and outdoor use (IP44). 3-hour autonomy for practical, portable lighting. Adjustable brightness for smooth, gentle light control. Charging time: 2 hours.</p> 
<p>LOOMPA</p> <p>Source's lifetime: 30.000 h Lux at 25 cm: 583 Material: Steel / PP 2 years warranty</p> <p>A ↑ G E</p> <p>Black 400 202 311 Green 400 202 312 Brick 400 202 313 Orange 400 202 314</p>		 <p>Ø 12,5 35 Ø 13</p>	<p>242 lumen (lm)</p> <p>2 W</p> <p>109 lm/W</p> <p>82 CRI</p> <p>3.000 K</p>	<p>Excellent 8-hour autonomy at maximum brightness. Easy recharging for effortless daily use. Suitable for indoor and outdoor use (IP44 rating). Touch dimming for customised lighting comfort.</p> 



TECHNICAL LAMPS



MINI ZOOM

MINI ZOOM

Source's lifetime: 50.000 h
Material: ABS, glass
2 years warranty



White 400 108 074

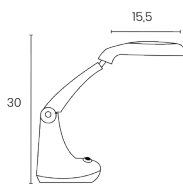

785
lumen (lm)

6
W

131
lm/W

83
CRI

6.000 K

MINI ZOOM is a double-jointed LED magnifying lamp with a swivel head equipped with a ball joint. Lens 3 diopters (x1,75) and inlay 12 diopters (x7) protected by a dust cover. Switch: ON/OFF on the base.



ZOOM

Source's lifetime: 50.000 h
Material: ABS, glass
2 years warranty



White 400 108 073

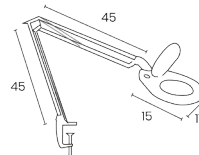

944
lumen (lm)

8
W

118
lm/W

84
CRI

6.200 K

ZOOM is an indispensable LED magnifying lamp for all activities requiring high precision or for any meticulous work. Magnification 3 diopters (x1,75). Switch on the head.



LIGHT THERAPY LAMPS

What is light therapy?

Light therapy is a non-medicinal therapy that aims to stimulate the retinal neuroreceptors through exposure to specially designed artificial light to achieve an optimal response. This will activate the secretion of serotonin, the “good mood and activity hormone” to prepare the body for a day full of vitality. The recurrence of the sessions will contribute to the resynchronisation of the biological rhythm and to the improvement of the general condition.

Numerous international studies show that light therapy helps to restore energy, fitness, the ability to concentrate and a good mood. Its action on sleep, seasonal and non-seasonal depression has also been widely demonstrated. Today, light therapy is becoming a recognised therapy and is increasingly used throughout the year.



Benefits and instructions for use

30 minutes of daily exposure, preferably in the morning, allows you to regain energy and a good mood for the whole day, to readjust the day/night cycle in order to have quality sleep, to fight insomnia, to obtain a daily dose of light in case of hospital stay, in Ehpad or working in a confined environment, and to better support jobs with shifting hours or time differences imposed by regular travel.

The first effects are felt very quickly, usually within the first week. Daily practice over a period of at least 4 weeks will ensure optimal results.

In all cases, it is important to read the instructions carefully to get the most out of your light therapy lamp or glasses. In case of eye problems such as glaucoma, cataract or any other medical problem, please consult your doctor to validate the use of a light therapy lamp beforehand.



The majority of Dayvia light therapy lamps and glasses are made in France.



All Dayvia products are certified CE Class I Medical Device

MOBILLY

Class I medical device.
Material: Aluminium, polycarbonate and wood or bamboo.
2 years warranty.

White/beech 400 180 141
Black/bamboo 400 178 700

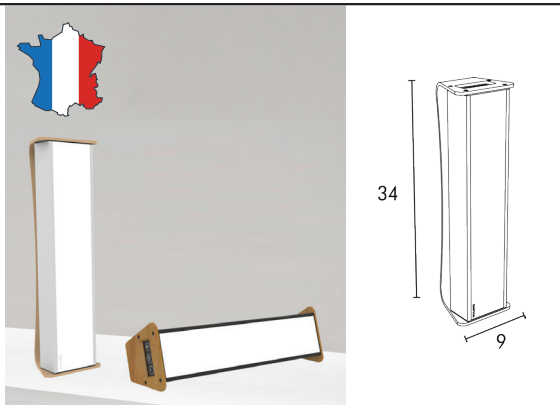

The modern MOBILLY lamp with pure desing brings a trendy touch to any interior. It can be used anymore, as it has a user-friendly handle. It is certified as CE Medical Device and offers two therapeutic lighting modes including the Blue Cyan mode targeted at 480 nm, which is particularly effective. It is available in white/beech or black/bamboo.



SUN ACTIV 2

Class I medical device.
Material: ABS and polypropylene.
2 years warranty.

White 400 159 056

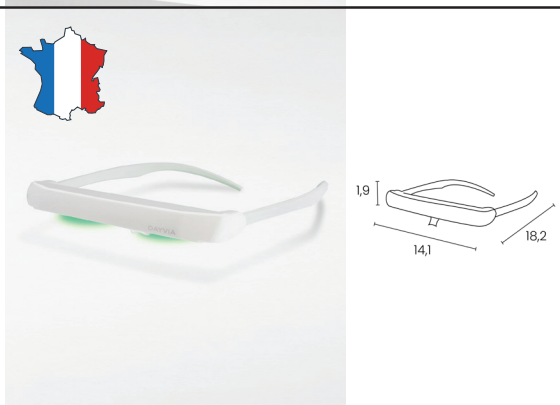

SUN ACTIV 2 is a light and easy to use light therapy device (only 45 g) that you can wear even if you have glasses. With 3 levels of intensity proposed, it is efficient to fight against winter blues, to treat some sleep disorders (early or late phase) and to prepare or recover from a long trip (jet-lag).



SLIM STYLE 3

Class I medical device.
Material: Aluminium, polycarbonate and ABS.
2 years warranty.

Black 400 149 953

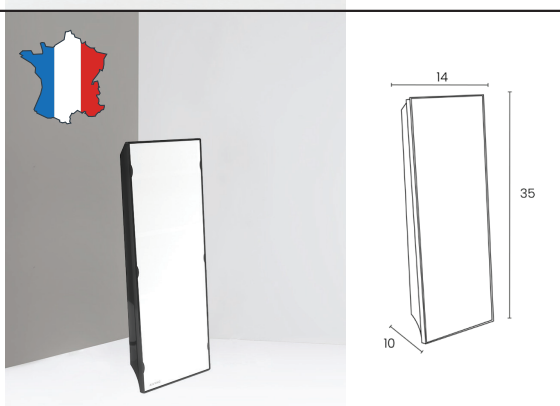

SLIM STYLE 3 is a compact lamp. Depending on the intensity of the lighting chosen and the distance from your eyes, you can make daily sessions of 30 to 60 minutes. Its touch-sensitive keyboard, easy to use and low power consumption (16.5 W) will be arguments in favour of this product.



SUNDESK 3

Class I medical device.
Material: Aluminium, steel and polycarbonate.
2 years warranty.

Black 400 149 954

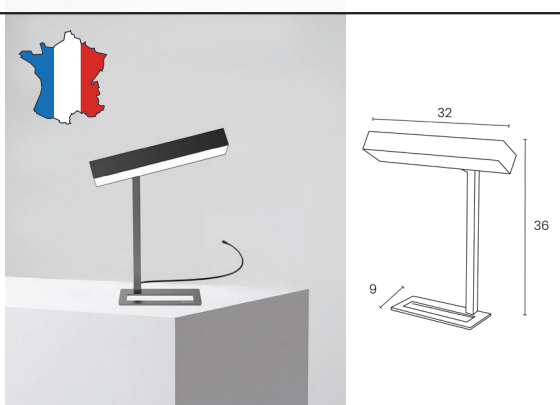

SUNDESK 3 was specially designed for use in the home or office. It can be adjusted by means of a joint: either in light therapy mode, directed towards the face, or in desk lamp mode with a softer white light directed towards the work surface. The combination of two types of Osram LEDs provides optimum and flexible light quality in accordance with the latest lighting recommendations.



WELLBI

Class I medical device.
Material: Aluminium, polycarbonate and steel.
2 years warranty.

White 400 179 590

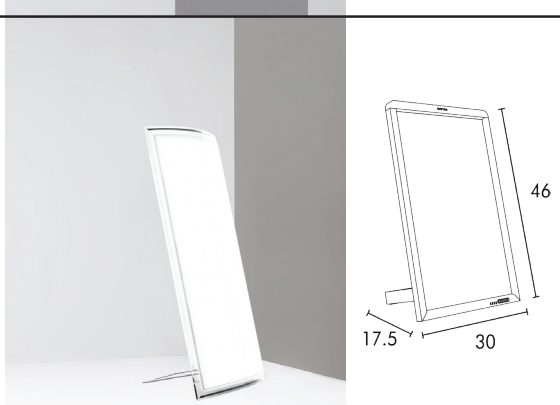

WELLBI is an easy to use light therapy lamp. It can be easily used at home or in the office. Thanks to its removable foot, it can be placed on surfaced or hung on the wall.



UPLIGHTERS WITH INDIRECT LIGHTING



LUMILIGHT

Source's lifetime: 25.000 h
Lux at 35 cm: 2.300
Material: metal, recycled aluminium
2 years warranty



Black 400 177 890

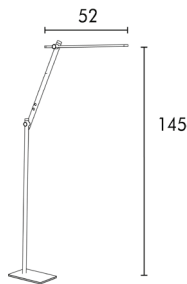

1.120 lumen (lm)
10 W
140 lm/W
>80 CRI
3.000 K - 6.000 K

The LUMILIGHT uplighter is a new generation of ergonomic lamp. It offers a wide range of motion thanks to its double joints and provides quality lighting thanks to its large, slender head and textured diffuser. The two touch switches allow to dim the light and adjust the colour temperature continuously.



FIRST LED

Source's lifetime: 40.000 h
Lux at 55 cm: 2.930
Material: metal, steel
2 years warranty



Metal grey 400 153 695
Black 400 153 696

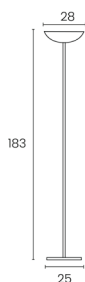

3.271 lumen (lm)
22 W
148 lm/W
83 CRI
3.000 K

FIRST LED is a powerful and energy saving LED uplight. Swivel lamp head. Quality lighting for a great visual comfort. Equipped with a foot switch on the cord.



LEDDY

Source's lifetime: 40.000 h
Lux at 55 cm: 3.690
Material: metal, steel, glass
2 years warranty



White 400 165 031

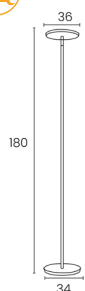

4.764 lumen (lm)
32 W
149 lm/W
84 CRI
3.000 K

LEDDY is a powerful led floor lamp (4764 lm) equipped with a tactile switch on the mast allowing to benefit from 3 light intensities. Its flat bowl gives it a discreet design.



FIRST LED ARTICULATED

Source's lifetime: 40.000 h
Lux at 55 cm: 2.930
Material: metal, steel, aluminium
2 years warranty



Black 400 153 694

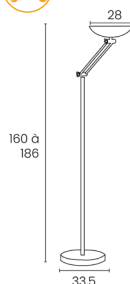

3.271 lumen (lm)
22 W
148 lm/W
83 CRI
3.000 K

FIRST LED articulated is a powerful and energy efficient LED floor lamp. Its tilting arm and swiveling bowl will allow you to position it close to a wall and to light more comfortably the whole room. Quality lighting for a great visual comfort. Foot switch on the cord.



DELY 2.0

Source's lifetime: 40.000 h
Lux at 55 cm: 3.570
Material: metal, steel, aluminium
2 years warranty



Metal grey 400 153 720
Black 400 153 721

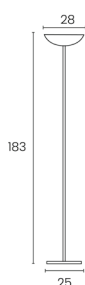

3.041 lumen (lm)
23 W
132 lm/W
82 CRI
3.000 K

DELY 2.0 is a powerful and energy efficient LED floor lamp. Swiveling bowl by ball joint. Qualitative lighting for a great visual comfort. Equipped with a dimmer switch on the mast.



INDIRECT LED UPLIGHTERS

VARIALUX LED

Source's lifetime: 40.000 h
Lux at 55 cm: 2.820
Material: metal, steel
2 years warranty



Metal grey 400 090 468

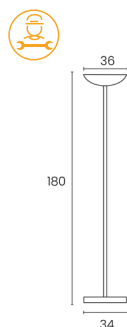

3.041 lumen (lm)
23 W
132 lm/W
82 CRI
3.000 K

VARIALUX LED is a low energy and low cost lamp. Its wide and weighted base gives it a great stability. Its dimmer switch located on the mast allows to adapt the level of luminosity.



DELY 2.0 ARTICULED

Source's lifetime: 40.000 h
Lux at 55 cm: 3.570
Material: metal, steel, aluminium
2 years warranty



Metal grey 400 153 697
Black 400 153 698

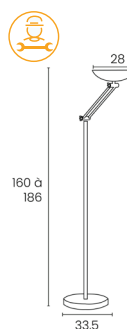

3.041 lumen (lm)
23 W
149 lm/W
82 CRI
3.000 K

DELY 2.0 articulated is a powerful and energy efficient LED floor lamp. Its tilting arm and swivel bowl will allow you to position it close to a wall and to light more comfortably the whole room. Quality lighting for a great visual comfort. Dimmer switch on the mast.

BALY BAMBOO

Source's lifetime: 40.000 h
Lux at 55 cm: 5.300
Material: metal, steel, bamboo
2 years warranty



White/bamboo 400 153 731
Black/bamboo 400 140 805

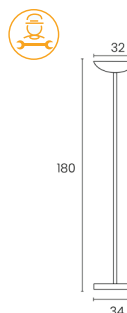

5.539 lumen (lm)
37 W
150 lm/W
83 CRI
3.000 K

BALY BAMBOO is a floor lamp that is both efficient, low energy consumption that will allow you to make real savings, and with a retro design. It has a tactile switch with 3 levels of light intensity, allowing everyone to adapt the lighting to their needs throughout the day: relaxation, work, reading.



VARIAGLASS LED

Source's lifetime: 40.000 h
Lux at 55 cm: 3.260
Material: metal, steel, glass
2 years warranty



Metal grey 400 090 473

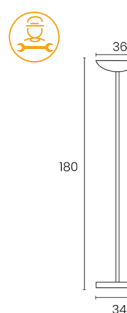

3.041 lumen (lm)
23 W
132 lm/W
82 CRI
3.000 K

VARIAGLASS LED is a low energy (132lm/W) and low cost lamp. Its wide and weighted base gives it a great stability. Its dimmer switch located on the mast allows to adapt the level of luminosity. Equipped with an enamelled glass bowl.



VARIALUX LED ARTICULED

Source's lifetime: 40.000 h
Lux at 55 cm: 2.820
Material: metal, steel
2 years warranty



Metal grey 400 090 471
Black 400 090 469

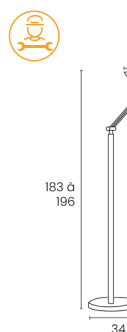

3.041 lumen (lm)
23 W
132 lm/W
82 CRI
3.000 K

VARIALUX LED ARTICULED is a low energy and low cost lamp. Its wide and weighted base gives it a great stability. Its articulation allows you to position it close to a wall and to optimize its lighting by centering the basin. Its dimmer switch located on the mast allows you to adapt the level of brightness.



PRYSKA

Source's lifetime: 40.000 h
 Lux at 55 cm: 5.300
 Material: metal, steel, wood
 2 years warranty



White/beechn 400 110 157

Black/beechn 400 153 677

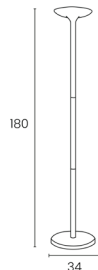

5.539
lumen (lm)

37
W

150
lm/W

83
CRI

3.000 K

PRYSKA is a powerful led floor lamp with indirect lighting. It is equipped with a touch dimmer 3 intensities and a 5 kg base guaranteeing a good stability.



ZELUX

Source's lifetime: 40.000 h
 Lux at 55 cm: 4.190
 Material: metal, steel
 2 years warranty



Metal grey 400 100 711

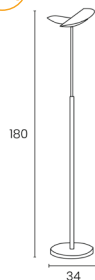

5.539
lumen (lm)

37
W

150
lm/W

83
CRI

3.000 K

ZELUX is a powerful and flexible LED floor lamp: direct and/or indirect lighting. Elegant and modern design. The ball-and-socket joint system allows the LED modules to be oriented independently and to direct the light according to the users' needs. Each module can be turned completely up or down to obtain direct/indirect lighting, particularly recommended by ergonomists. Dimmer switch on the pole.



LUMILIGHT



UPLIGHTERS WITH DIRECT/INDIRECT LIGHTING

Bright lighting and space on the workspace

Good lighting creates an even and pleasant illumination of a room and does not dazzle.

A desk lamp emits its light into the room or onto the usable area where the light is needed, this is called direct lighting. Direct lighting is used when precise details need to be seen. As a result, no light is wasted and maximum light output is guaranteed. Unfortunately, direct lighting only illuminates a small part of the room and that very strongly. Therefore, it is not beneficial for relaxing the eyes.

Indirect lighting is generated, for example, by an uplighter. Here the cone of light is not directed downwards, rather it is either thrown onto the ceiling or wall and reflected off of it. This light isn't very suitable for concentrated work or reading because it unnecessarily strains the eyes, but it creates a pleasant room atmosphere.

The combination of both types of lighting is therefore recommended, as this lighting is perceived as pleasant.

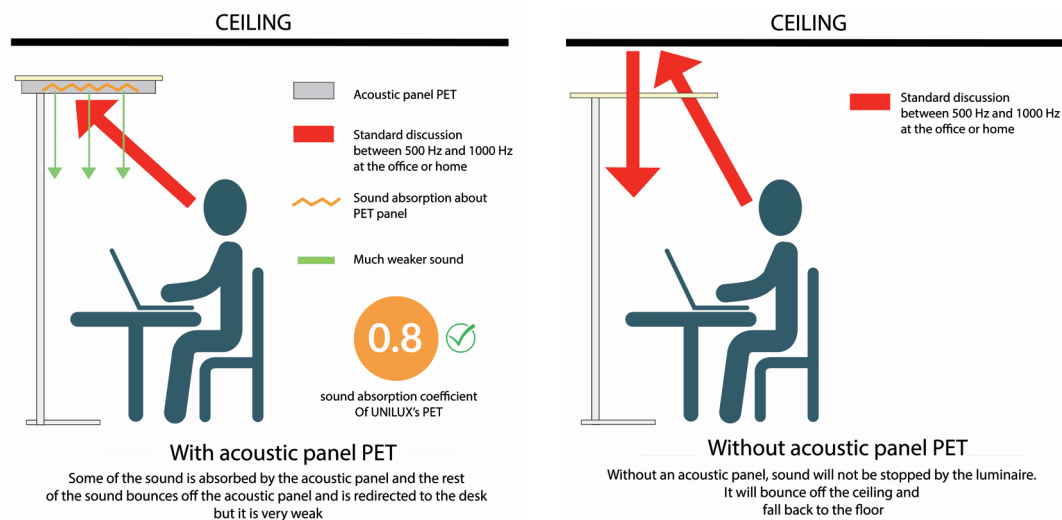

<p>OPUS</p> <p>Source's lifetime: 40.000 h Lux at 110 cm (indirect): 646 Lux at 50 cm (direct): 3.000 Material: Aluminium recycled/steel/ABS 2 years warranty</p> <p>A ↑ D</p> <p>Black 400 188 813</p>			<p>7.827 lumen (lm)</p> <p>51 W</p> <p>102 lm/W</p> <p>82 CRI</p> <p>3.000 K</p>	<p>Touch controls to combine or separate direct and indirect lighting. Adjustable brightness for personalized visual comfort. Balanced distribution of direct and indirect light for optimal illumination. Airy design thanks to its innovative circular shapes.</p>
<p>VERSUS</p> <p>Source's lifetime: 40.000 h Lux at 110 cm (indirect): 1.100 Lux at 50 cm (direct): 3.700 Material: Aluminium recycled / steel 2 years warranty</p> <p>A ↑ D</p> <p>White 400 191 230 Black 400 188 812</p>			<p>6.943 lumen (lm)</p> <p>65 W</p> <p>107 lm/W</p> <p>84 CRI</p> <p>4.000 K</p>	<p>Touch controls allowing you to combine or separate direct and indirect lighting. Balanced lighting with 50% direct / 50% indirect output for optimal visual comfort. Adjustable brightness tailored to your needs. U-shaped steel base designed to fit easily around the desk.</p>

DIRECT/INDIRECT LED UPLIGHTERS

COCOON

Source's lifetime: 40.000 h
Lux at 55 cm (indirect): 1.981
Material: Steel / PE
2 years warranty



Black 400 202 317

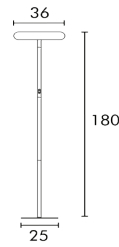

4.625 lumen (lm)
37 W
125 lm/W
84 CRI
3.000 K/
4.000 K

Dynamic white lighting for direct and indirect illumination that enhances concentration.
Warm 360° lighting to create a relaxing and comforting atmosphere.
Three-level dimming for optimal comfort.



ATLAS

Source's lifetime: 40.000 h
Lux at 110 cm (indirect): 1.368
Lux at 55 cm (direct): 7.176
Material: Aluminium / steel / PMMA
2 years warranty



Black 400 202 686

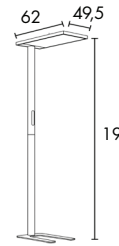

10.799 lumen (lm)
80 W
136 lm/W
<16 UGR
4.000 K

Touch controls to combine or separate direct and indirect lighting.
Balanced lighting with 30% direct / 70% indirect for optimal visual comfort.
Adjustable intensity to adapt brightness to your needs.
Smart sensors detecting motion and ambient light to automatically adjust illumination.



NEXUS

Source's lifetime: 40.000 h
Lux at 55 cm: 2.330 / 110 cm: 1.380
Material: metal, aluminium
2 years warranty



White/beige 400 165 148

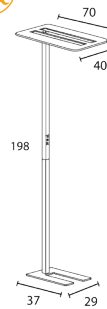

5.935 lumen (lm)
54 W
110 lm/W
84 CRI
4.000 K

NEXUS is the first luminaire that combines both lighting and sound absorption thanks to its acoustic panel made of PET (50% recycled/50% recyclable) that reduces noise.
NEXUS allows you to dim the light and choose to light up or down or both at the same time thanks to its separate lighting function.
Automatic adjustment of the intensity according to the ambient light and energy saving thanks to its cell with presence detection.



LIXUS

Source's lifetime: 40.000 h
Lux at 55 cm: 3.700 / 110 cm: 1.070
Material: metal, aluminium
2 years warranty



Metal grey 400 079 771

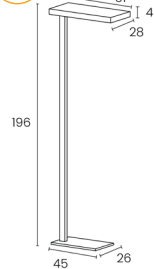

7.492 lumen (lm)
60 W
125 lm/W
83 CRI
4.100 K

LIXUS is an ergonomic and economical LED floor lamp. With direct lighting (40%) and indirect lighting (60%), it provides optimal light distribution in the workspace. Its LED lighting provides low power consumption for powerful lighting. Its microprismatic diffuser gives it anti-glare properties.
The rotary switch on the mast is easily accessible and allows the user to adjust the intensity of the lighting according to his needs.



STRATUS

Source's lifetime: 40.000 h
Lux at 55 cm: 2.070 / 110 cm: 1.370
Material: metal, aluminium
2 years warranty



Metal grey 400 124 564

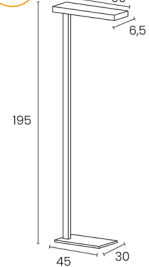

6.581 lumen (lm)
50 W
132 lm/W
83 CRI
4.100 K

STRATUS is a floor lamp with a slim and narrow head. Its light output of 6.581 lm is evenly distributed between direct and indirect lighting.
Touch dimmer switch under the head.



Biodynamic lighting : a source of well-being

Light has a strong influence on our physical and mental behaviour. It affects our concentration, creativity, and therefore our productivity.

In the morning, light is enriched with so-called “blue” wavelengths, which suppress melatonin secretion and help energize you by boosting concentration.

In contrast, at sunset, melatonin production increases thanks to warmer light tones rich in red and orange, helping you relax and fall asleep more easily.

Sleep disorders, mood changes, headaches, and eye fatigue can impact both your professional life and your overall well-being.

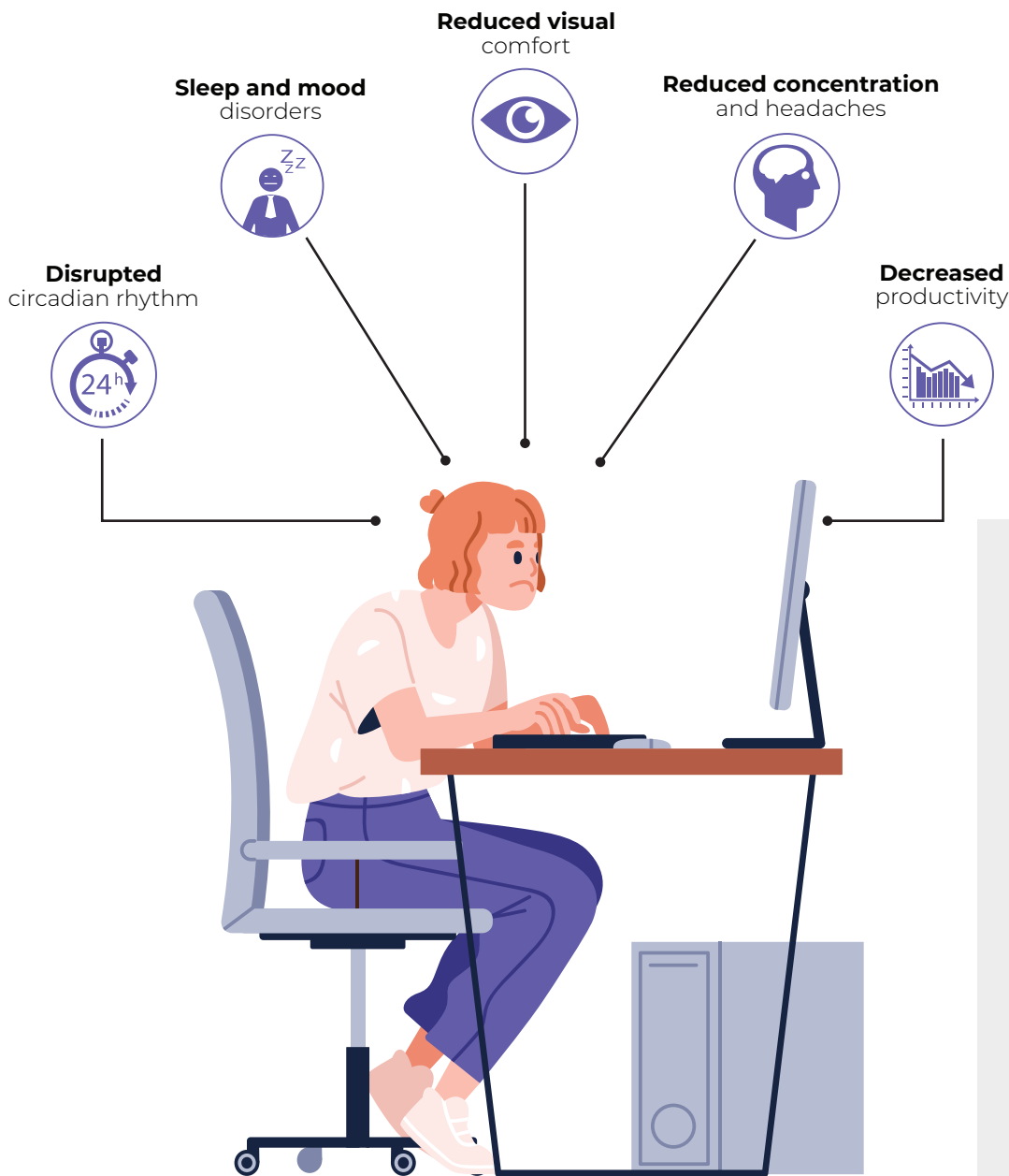

Did you know?

34%

of offices reach the recommended illuminance level of 500 lux on the work surface, as advised by occupational health guidelines.

29%

of employees report suffering from eye fatigue.

How to properly **light** your workspace ?

Tip No. 1
Position the lamp head at least 35 cm above the work surface and on the opposite side of your writing hand.



Tip No. 2
Choose asymmetrical lighting, which helps eliminate unwanted reflections on your screen.

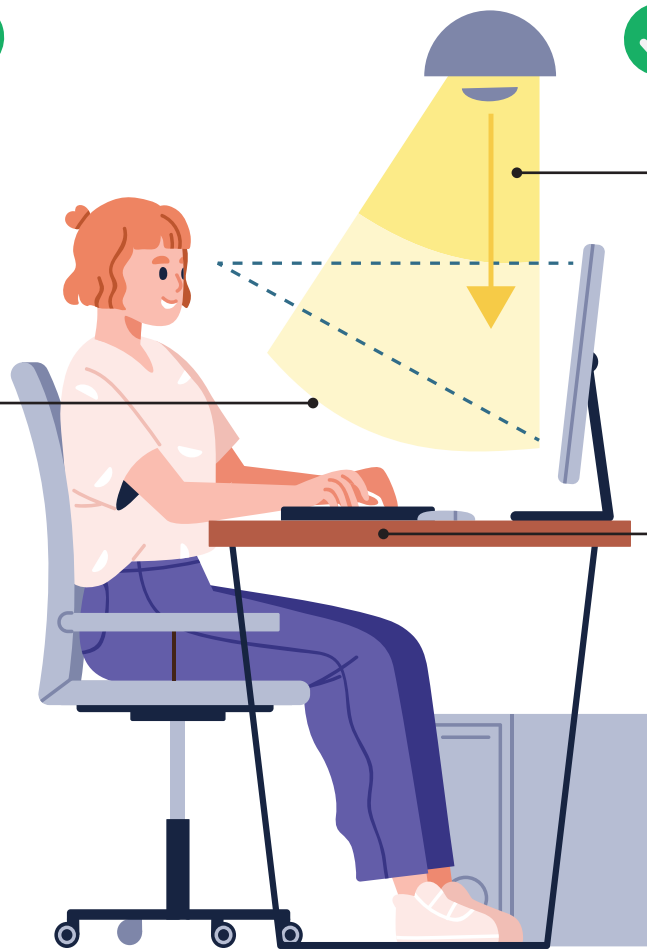

Tip No. 3
Avoid reflections on glossy surfaces



Adopting **biodynamic lighting** that supports you throughout the day will help you **perform** better, feel **more energised**, and maintain a **positive mood**.

What is the circadian rhythm ?

The circadian rhythm is a biological cycle that influences a range of human physiological processes such as cognitive abilities, the sleep-wake cycle, heart rate, mood, memory, and body temperature. It is linked to the Earth's rotation, lasts approximately 24 hours, and is regulated by light, which acts as a natural synchroniser. It is therefore essential to respect natural light, reproduce it as accurately as possible around us, and integrate it into our working environment.

AXIO: A new generation of monitor arms

Much more than a simple monitor arm, the AXIO range offers an innovative solution that combines the prevention of musculoskeletal disorders with the benefits of biodynamic lighting. Its central mast — the true backbone of this monitor arm system — enhances both ergonomics and overall well-being.





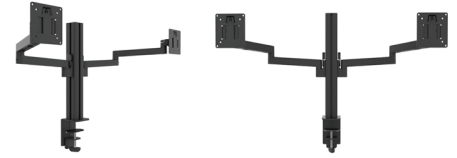

References

/ AXIO single mechanical arm

/ AXIO double mechanical arms

Key features

- **Organized and ergonomic workspace** for greater efficiency throughout the day
- **Quick adjustment** of the screen in height, tilt, and depth to ensure optimal posture and improved visual comfort
- **Innovative and scalable concept** enhanced with numerous accessories to meet all your professional needs

- **Patented locking system** allowing quick locking and unlocking of the arms for maximum user comfort
- **Optimized desk space** by elevating the screens and freeing up the work surface
- **Sliding arms with integrated cable management** for a clean, elegant and ergonomic workstation
- **Modular solutions** designed to evolve with your needs and adapt to every user

SAP code

400204097

400204099

Height (cm)

16,5 to 50,6

16,5 to 50,6

Screen size

13" - 36"

13" - 36"

Max load (kg)

10

2 x 10

VESA (mm)

75 x 75 & 100 x 100

75 x 75 & 100 x 100

Rotation

+180° ~ -180°

+180° ~ -180°

Swivel

+90° ~ -90°

+90° ~ -90°

Materials

Aluminium / steel / ABS

Aluminium / steel / ABS

Product dimensions

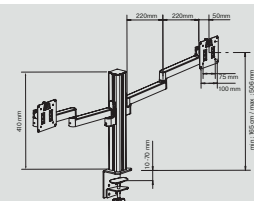
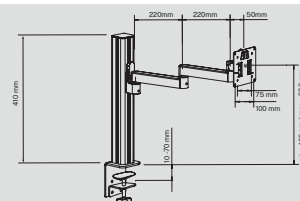

Ergonomics - screen arms supports

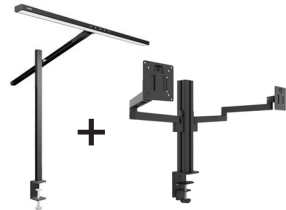

/ ELITE lumino screen

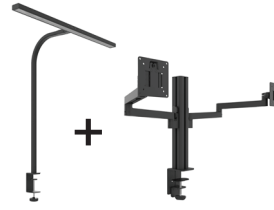

/ STRATA lumino screen

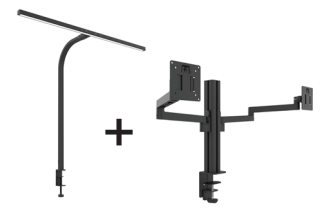

/ STRATA screen

References

Key features

- **Ergonomic lighting** to illuminate your workstation while enhancing overall comfort
- **Rotating and sliding arm** allowing you to direct the light with a simple, intuitive gesture
- **Comfort, clarity and productivity improved** thanks to asymmetric lighting combined with light therapy

- **Quick assembly** for effortless installation of the lamp onto the AXIO support arm
- **Modular and seamless duo compatible** with all types of screens
- **Enhanced well-being and visual comfort** thanks to asymmetric lighting and integrated light therapy

- **Innovative concept** combining lighting and ergonomics for an optimised workstation
- **Asymmetric lighting** ensuring optimal visual comfort with no screen reflections
- **Multiple ergonomic configurations** designed to adapt to all your needs

SAP code	400207202	400207200	400207201
Lumens (lm)	2993	2993	2046
Lux (lx)	3672 at 40 cm	3672 at 40 cm	2400 at 40 cm
Color temperature (K)	3000 / 4000 / 5000 / 6500	3000 / 4000 / 5000 / 6500	3000 / 4000 / 5000 / 6500
Consumption (kWh / 1000h)	D	D	E
Energy class (A to G)	13" - 36"	13" - 36"	13" - 36"
Lifespan (h)	2 x 10	2 x 10	2 x 10
Materials	Aluminium recycled / steel / ABS	Aluminium recycled / steel / ABS	Aluminium recycled / steel / ABS

Product dimensions

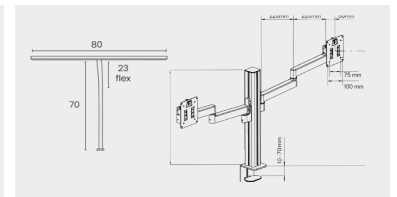
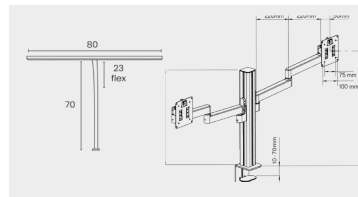
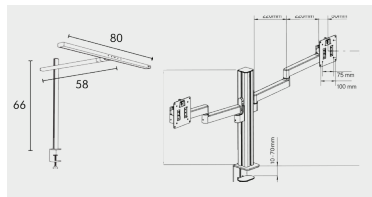

AXIO : Tailor-made customization

Our sliding arm supports adapt seamlessly to all work environments, delivering both flexibility and ergonomic comfort to your workspace. AXIO offers a wide range of modular components, allowing you to create dynamic configurations tailored to the needs of every user.

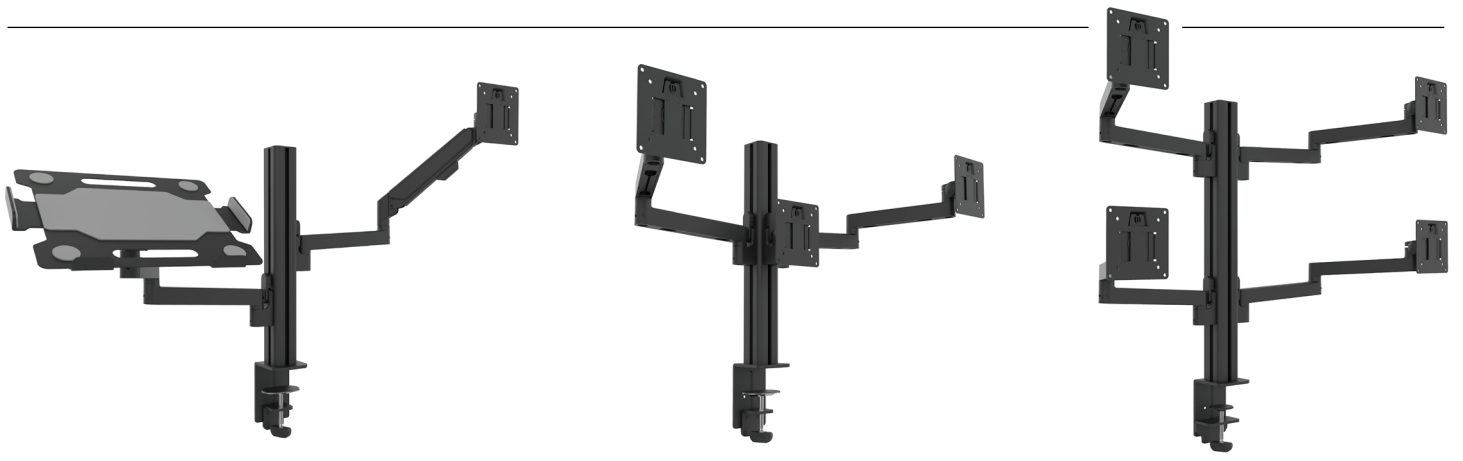
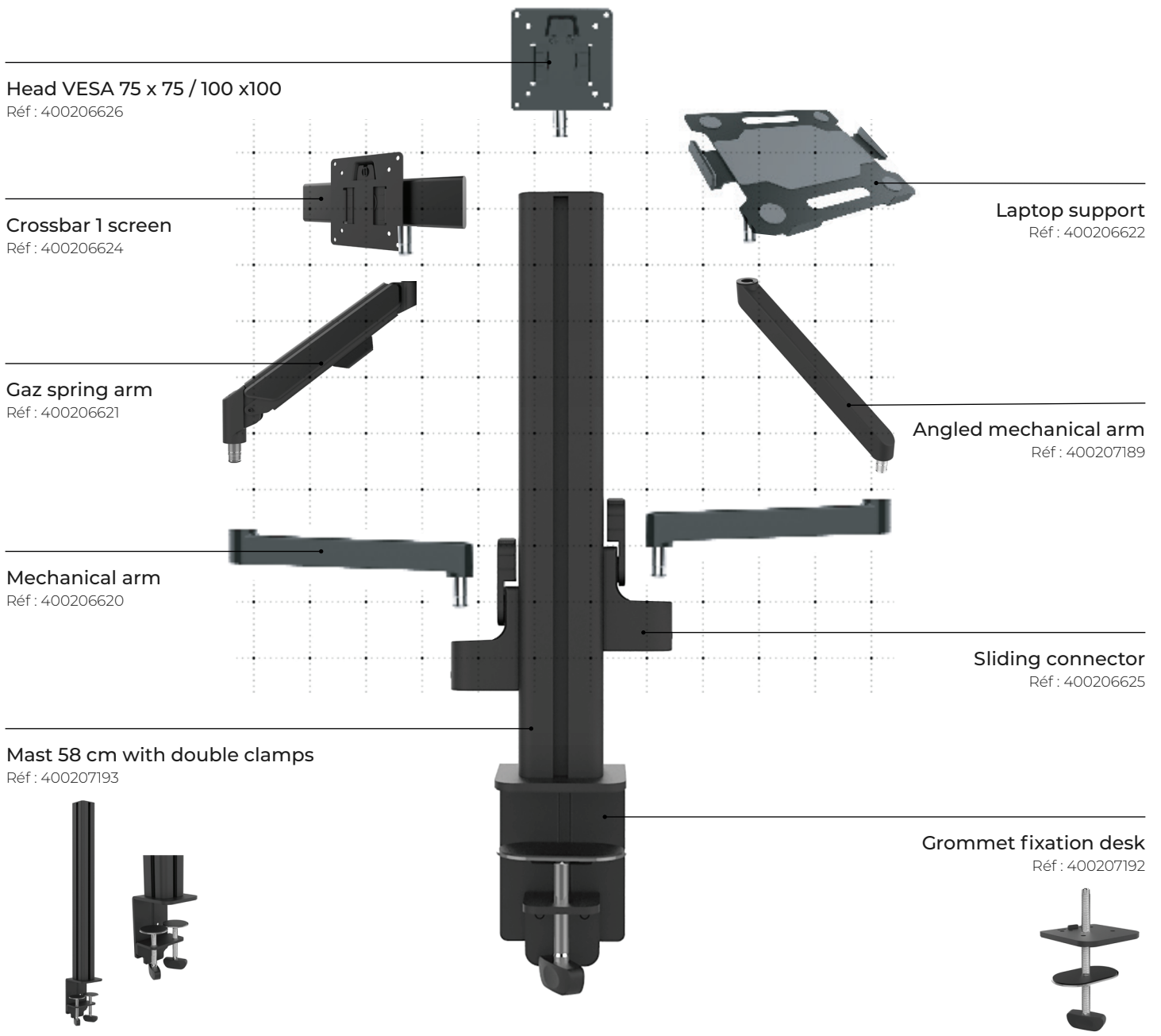

Gaz spring arm
+ laptop support

Mechanical arms
+ 3 heads

Mechanical arms
+ Mast 58 cm + 4 heads

Ergonomics - screen arms supports



/ Head VESA 1 screen



/ Crossbar 1 screen



/ Laptop support

References

Key features	<ul style="list-style-type: none"> • Multiple adjustments including pivoting, tilting, and rotating for optimal flexibility of use. • Extended configuration possible with a third VESA head integrated into the central groove of the AXIO mast, ideal for working with three screens. 	<ul style="list-style-type: none"> • Multiple adjustments with tilt, rotation, and dual lateral sliding to fit all screens from 10" to 36". • Quick VESA locking system for a secure and effortless installation. 	<ul style="list-style-type: none"> • Ergonomic design to correctly position laptop screens for optimal posture. • Reduced muscle strain in the neck area for greater everyday comfort. • Wide compatibility with laptops up to 17.3".
	SAP code	400206626	400206624
Screen size	13" - 36"	13" - 36"	10" - 17,3"
Max load (kg)	10	10	9
VESA (mm)	75 x 75 & 100 x 100	75 x 75 & 100 x 100	75 x 75 & 100 x 100
Dimensions (cm)	11,5 x 11,5 x 7	21 x 11,5 x 11,5	28 x 23 x 5
Net weight (kg)	0,5	0,81	1,03 kg
Materials	Steel / aluminium / ABS	Steel / aluminium / ABS	Steel / silicon



/ Mechanical arm



/ Angled mechanical arm



/ Gaz spring arm

References

Key features	<ul style="list-style-type: none"> • Intuitive height and depth adjustment for optimal screen positioning • Enhanced stability and precision ensuring long-lasting comfort • Integrated cable management for a clean and functional workspace 	<ul style="list-style-type: none"> • Stable and flexible installation ensuring secure screen positioning • Ergonomic comfort improving posture and helping prevent MSDs • Integrated cable management for a clean and functional workspace 	<ul style="list-style-type: none"> • Smooth height adjustment to adapt the screen to your posture and body shape • Effective pain prevention by reducing neck, shoulder and back strain through proper alignment • Reduced eye fatigue by naturally aligning your eyes with the top of the screen
	SAP code	400206620	400207189
Max load (kg)	10	10	10
Dimensions (cm)	25 x 7,5 x 3	27 x 24 x 3	34 x 7 x 4
Net weight(kg)	0,35	0,8	1,43
Materials	Aluminium / ABS	Aluminium / ABS	Aluminium / ABS



/ Sliding connector



/ Grommet fixation desk



/ Mast 58 cm double clamp

References

Key features	<ul style="list-style-type: none"> • Easy insertion into the three AXIO mast grooves to securely attach arm segments or accessories. • Quick locking and unlocking thanks to an intuitive rotating latch ensuring simple and safe handling. 	<ul style="list-style-type: none"> • Fast installation by drilling directly into the work surface. • Ergonomic solution ideal for a functional and customized workstation layout. • Optimized space thanks to simple adjustments tailored to your needs. 	<ul style="list-style-type: none"> • Custom configurations possible by combining multiple sliding connectors to create multi-screen or multi-accessory setups. • Robust steel clamp (4 mm thick) with two tightening screws ensuring optimal stability.
	SAP code	400206625	400207192
Max load (kg)	10	20	40
Dimensions (cm)	10 x 5,5 x 3	10 x 9,5 x 9	72 x 9 x 9
Net weight (kg)	0,18	0,37	2,5
Materials	Aluminium / ABS	Steel / Aluminium / silicon	Aluminium / steel / ABS

Ergonomics – monitor arms



References

/KORO single gaz spring arm

/KORO double gaz spring arm

Key features

- **Smooth height adjustment** to adapt the screen to your posture and body shape
- **Enhanced ergonomic comfort** by reducing neck, shoulder and back pain
- **Reduced eye fatigue** thanks to natural alignment with the top of the screen
- **Discreet cable management** for a clean and harmonious workspace

- **Multiple adjustments** including tilt, rotation and pivot of both screens for personalized comfort
- **Quick-lock VESA 75 & 100 system** for simple and secure installation
- **Innovative clamp mechanism** for effortless and intuitive setup

SAP code	400207190	400207191
Height (cm)	13 to 43,6	13 to 43,6
Screen size	13" - 32"	13" - 32"
Max load (kg)	9	2 x 9
VESA (mm)	75 x 75 & 100 x 100	75 x 75 & 100 x 100
Rotation	+180° ~ -180°	+180° ~ -180°
Swivel	+90° ~ -90°	+90° ~ -90°
Materials	Aluminium / steel / ABS	Aluminium / steel / ABS

Product dimensions

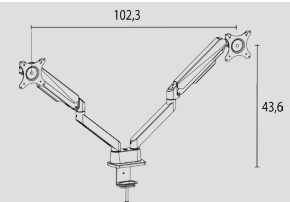
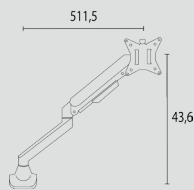





ERGONOMIC ACCESSORIES

By designing spaces and workplaces that promote comfort, safety and efficiency, ergonomic principles aim to minimize the risk of physical strain, injury and discomfort. By integrating suitable seating, adjustable workstations and ergonomic accessories, workplaces are intended to increase general well-being and performance so that individuals can work more comfortably and productively.

HOME OFFICE MUST-HAVES	60
DYNAMIC SEATS	61
FOOTRESTS	63
MONITOR & LAPTOP SUPPORT	65

MSDS : the **leading cause** of occupational illness in France

Musculoskeletal disorders are imbalances affecting the musculoskeletal system. They involve both the upper and lower limbs and include all conditions located in or around the joints: wrists, elbows, shoulders, neck, spine or knees.

In addition, a 37% increase in psychological distress has been observed, closely linked to MSDs. Studies also show that women are more affected than men (55% vs. 45%), particularly after age 45. It is essential to remain vigilant, as these disorders can become exhausting and highly restrictive in daily life.

This shows that workplace ergonomics and well-being have become major priorities for companies.

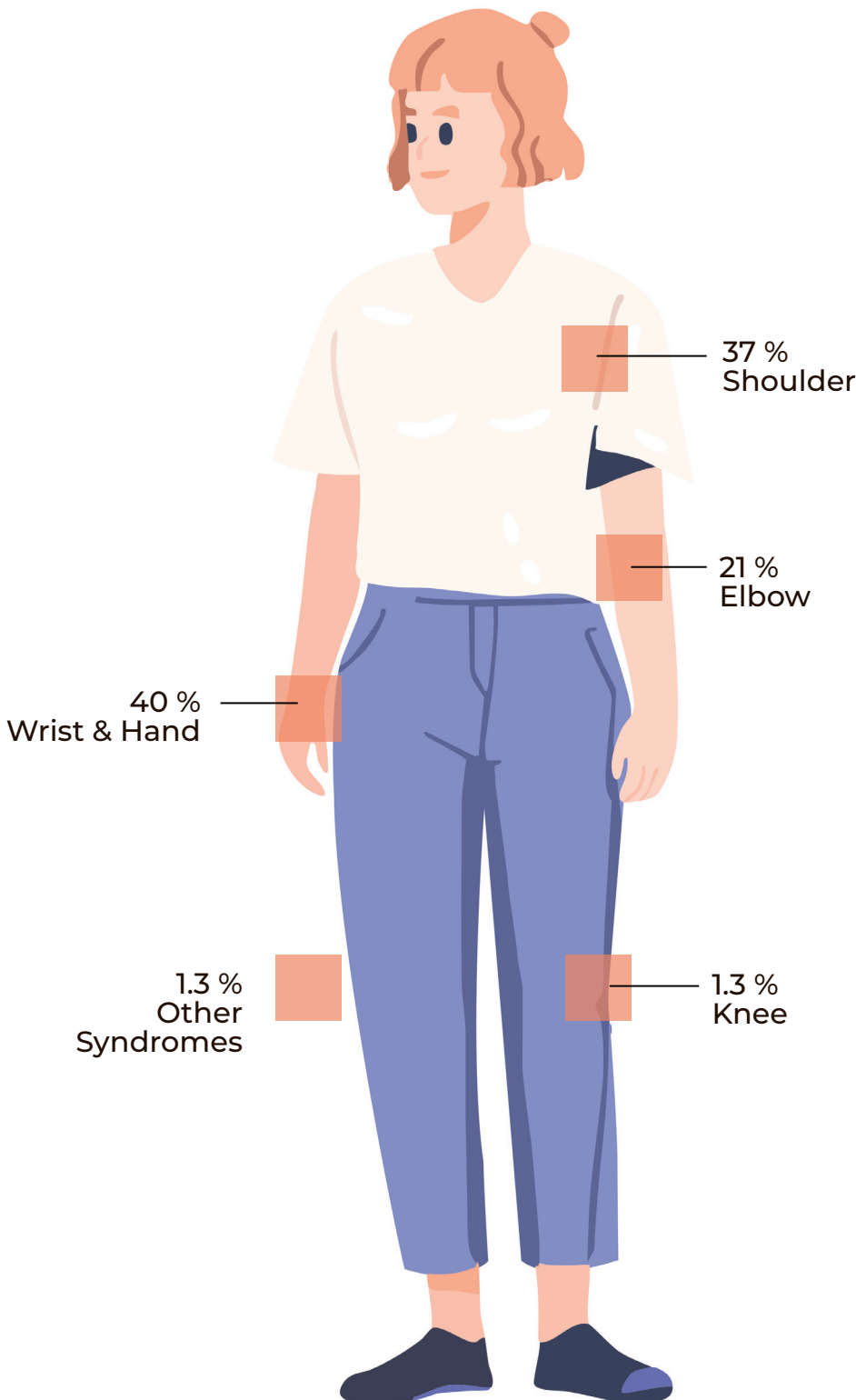

Did you know?

30%

sick leave* are caused by MSDs. This increases staff turnover within companies

22

millions of workdays* millions of workdays are lost due to MSDs, particularly because of back pain

Aligned back
Maintaining the spine in its natural posture helps prevent lower back pain

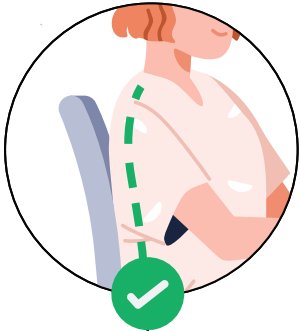

Eye-level screen
Reducing visual fatigue and neck strain

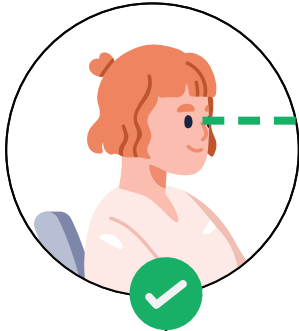

Ergonomic chair and dynamic seating
Providing long-lasting comfort to stay focused throughout the day and combat sedentary habits



Adjustable footrest
Keeping your feet flat on the floor or supported by a footrest helps promote healthy blood circulation

Workplace ergonomics :

Workplace ergonomics is essential for enhancing the performance, engagement, and efficiency of your teams. A well-equipped workspace in which you feel comfortable helps strengthen happiness and well-being at work, contributing to greater serenity. Office employees generally spend most of their time seated in front of a computer screen — an average of 8 hours a day for 28 years. Moreover, 8 out of 10 French employees report having already experienced pain.

HOME OFFICE DESK

Due to advancements in technology, which enable effective remote collaboration, a greater emphasis on work-life balance, and the lessons learned during the COVID-19 pandemic the feasibility and benefits of flexible work arrangements are now trending. Hybrid working is a flexible approach to work that combines both remote and in-person elements. In this dynamic setup, employees have the freedom to choose where and when they work, striking a balance between working from a traditional office, home, or other remote locations. Hybrid working harnesses the power of modern technology and communication tools, allowing teams to collaborate effectively and stay connected, regardless of their physical locations. As the business world adapts to the ever-evolving landscape, hybrid working is becoming an integral part of the new normal, providing both employers and employees with greater flexibility and efficiency.



HOMY

Material: steel and chipboard with melamine coating.
2-year warranty.



The foldable desk HOMY with its steel frame is ideal for mobile working and small working environments. There is no installation needed, can be used directly. When not in use, it can be folded, make it easy to store and transport.

White/beech 400 165 232

DYNAMIC SEATS

Combating sedentary lifestyles

According to numerous studies, sitting increases the risk of heart problems and reduces life expectancy by 7 years. Indeed, the human body is designed to “move”, not to remain almost immobile for 9 hours a day. In the end, this position disturbs the entire body (less oxygenated) which leads to an increase in fat cells causing potential overweight. To avoid back, lumbar and muscular pains (shoulders, arms, back), dynamic seats are designed to help get a good posture by inducing the tilting of the pelvis and forming an open angle of 110° between thighs and spine thus decreasing the tension exercised on pelvic muscles. This natural posture prevents back pain and improves muscle tone without hindering movements.

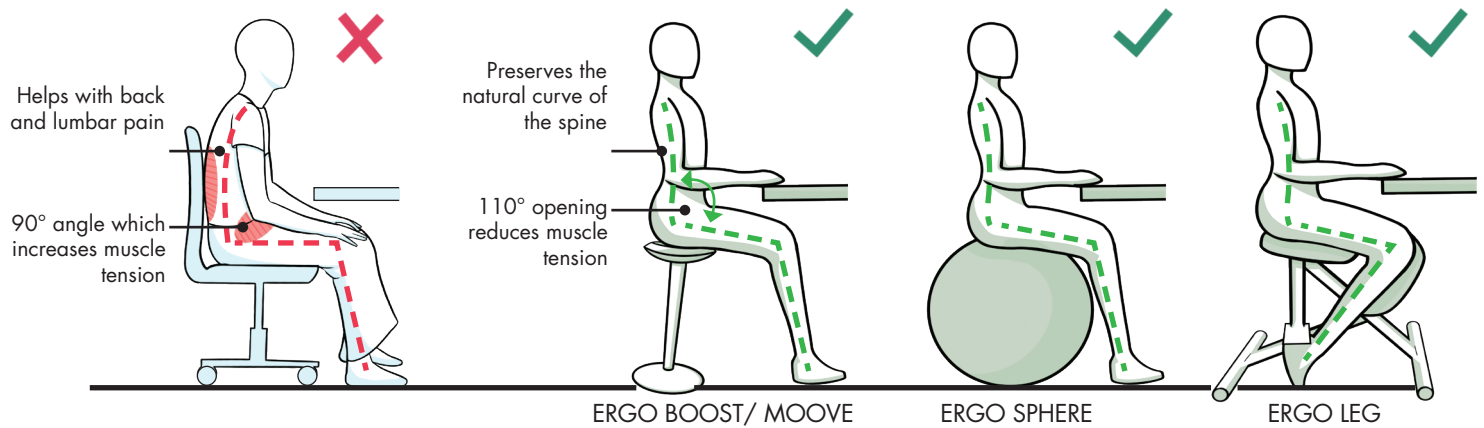

ERGO BOOST

Material: steel, ABS, fabric
2 year warranty.

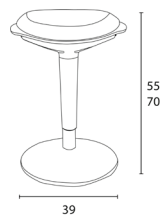

ERGO BOOST promotes dynamic posture while stabilizing movement with its innovative «diamond» base design. This base design allows you to stabilise your position and thus adopt the right posture without hindering your movements. Ideal to avoid back, lumbar and muscle pain (shoulders, arms, back). Thanks to the perfect alignment of the spine, the whole body «benefits».

White 400 165 092

MOOVE

Material, steel, ABS, rubber, fabric
2 years warranty.

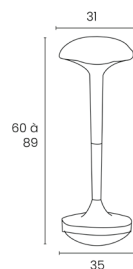

MOOVE favors with its curved foot, a dynamic posture and allows a greater freedom of movement and thus will help you to adopt a good position. It is ideal to avoid back, lumbar and muscular pains (shoulders, arms, back). Thanks to a perfect alignment of the spine, the weight on the pelvis is reduced, the respiratory tract is freed, the sheathing is solicited and the blood circulation is more fluid. In addition, it is proven that sit/stand stools have a positive impact on productivity, creativity and concentration.

Black 400 110 242

ERGONOMIC ACCESSORIES

ERGO LEG

Material: steel, foam, fabric
2 years warranty.

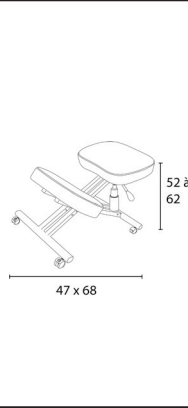

The dynamic seat is made of high density foam covered with a resistant fabric. It has a steel frame and 2 lockable wheels. ERGO LEG is designed to correct posture. The inclination of the seat and the knee rests reduce the pressure on the spine, lumbar region, back, shoulders and neck after several hours of sitting.

You can manually adjust the angles of this seat (5 levels). It is also possible to adjust the height from 52-62 cm thanks to its hydraulic jack. It will adapt to all morphologies.

Black /metal grey 400 165 094

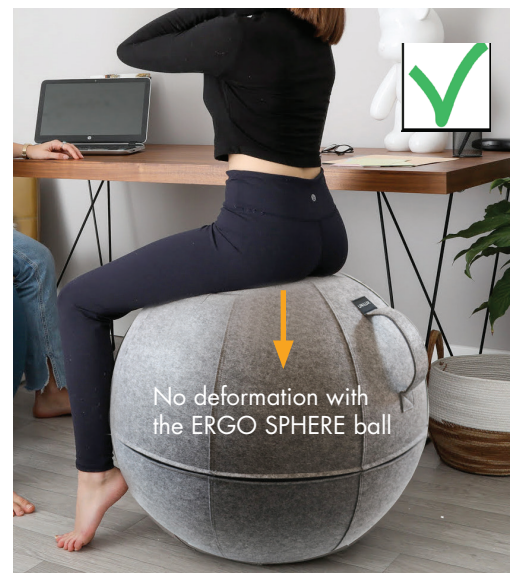

ERGO SPHERE

Material: rubber, polyester
2 year warranty.

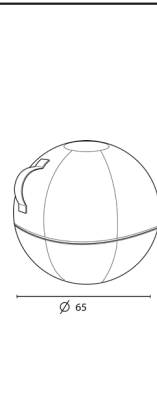

This 65 cm ball is perfectly suited for adults and children between 1.55 and 1.85 m tall and with a maximum weight capacity of 120 kg. ERGO SPHERE is recommended for workers who sit all day, for people who want to improve their posture, for those who want to be active / dynamic even while sitting! But it can also be used for physical activities/exercises like yoga, pilates, gymnastics or fitness. The inner ball is a shatterproof PVC sports ball with a felt cover. The ERGO SPHERE ergonomic seat works the balance and the deep muscles of the abdomen and back, which helps to treat back pain.

Grey 400 165 093

FOOTRESTS

A footrest is not just a matter of convenience; it's a crucial element of creating a healthy and comfortable workspace. While spending long hours at a desk or while enhancing the overall comfort, a footrest is a practical addition that can improve the posture, well-being, and productivity. Therefore, a footrest helps maintain proper ergonomic posture while sitting. It allows to keep the feet flat on the floor, which promotes a more neutral spine position, reducing the risk of back pain and discomfort.

Prolonged sitting can also cause pressure to build up in the legs, leading to discomfort and potential health issues. A footrest encourages circulation by letting shift weight and move legs, reducing the strain on lower limbs. By providing a stable and comfortable surface for the feet, a footrest can help concentrate better on tasks. It minimizes the fidgeting and restlessness that can be distracting when feet dangle or don't have proper support. Another benefits of footrest are the adjustments, allowing to find the perfect height for comfort. This adaptability is especially useful for individuals of various heights or those with different seating preferences. People with conditions like swelling, varicose veins, or edema can benefit from a footrest. Elevating the feet can reduce the pressure and alleviate discomfort associated with these issues. Keeping the feet on a footrest can prevent blood from pooling in lower extremities, reducing the risk of circulatory problems. Good blood flow is essential for overall health.

Maintaining a comfortable posture with a footrest can reduce stress and tension in the lower back and legs. This can have a positive impact on mental and physical well-being.

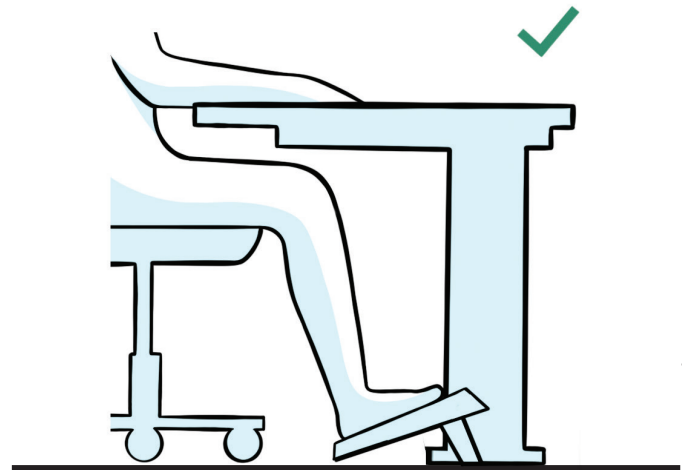

TILTING FOOTRESTS

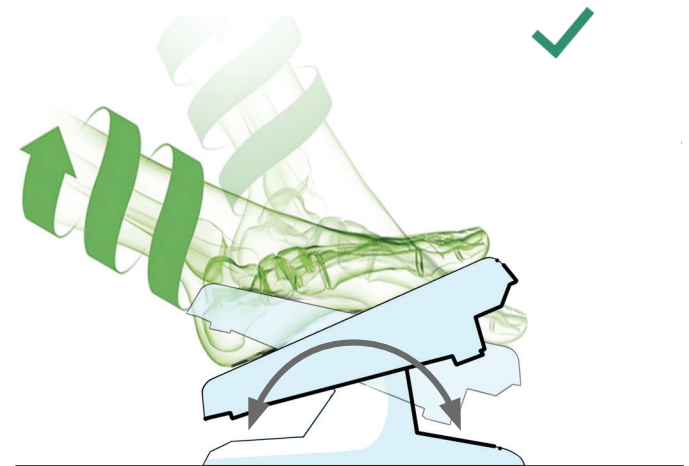

DYNAMIC FOOTRESTS

BALANCY

Material: FSC wood / rubber
2 year warranty.

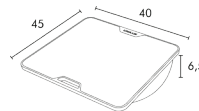
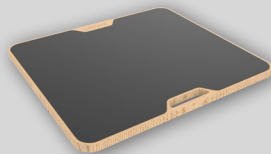

Ideal for combating sedentary habits and encouraging movement.
Versatile use whether seated or standing, depending on your needs.
Certified DIN 4556.
Non-slip surface ensuring perfect stability.

Wood Beech 400 188 804

ORIGIN

Material: ABS, PVC
10-year warranty.

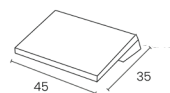
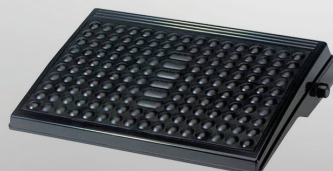

ORIGIN is a footrest that helps to reduce and prevent muscular pain and back fatigue due to poor posture. Promotes blood circulation.
Adjustable in height from 10 to 13.5 cm and in inclination: 10°, 15°.
It adapts to all morphologies. Its anti-allergenic surface made of half-spheres ensures a relaxing massage of the arch of the foot.

Black 100 340 819

ERGONOMIC ACCESSORIES

CHRYSALIS OCEANIS

Material: recycled PP, ABS, PVC
2-year warranty

■ Blue oceanis 400 179 659

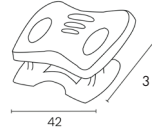
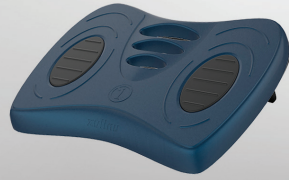

The CHRYSALIS of the Oceanis range is an eco-friendly version of the classic polypropylene CHRYSALIS. Its tray is made of 100% recycled PP manufactured by a Danish factory from the recycling of used fishing nets and fishing ropes. Developed with ergonomists. Prevents muscular pain and back fatigue due to poor posture and promotes blood circulation. Adjustable in inclination: 10°, 15° and 20° thanks to its removable notched feet: adapts to all morphologies. These PVC glides ensure perfect stability.

CHRYSALIS

Material: ABS, PVC
2-year warranty.

■ Black 100 340 820



NYMPHÉA

Material: PP, PVC
10 years warranty

■ Black 100 340 822

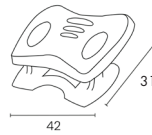
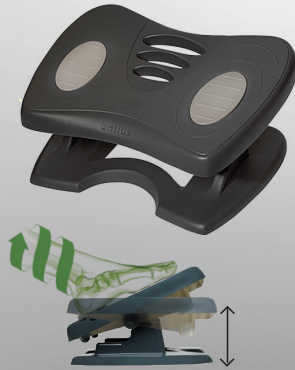

NYMPHEA is a footrest developed with occupational medicine. Helps to avoid muscular pains and back fatigue linked to a bad posture. Promotes blood circulation. Adjustable in height from 12 to 17 cm and inclination from 0° to 20° thanks to its axis system: adapts to all morphologies. Tray equipped with a non-slip support surface to maintain the feet naturally. Base ensuring perfect stability.

CHOCOLATE

Material: PP, PVC
10 years warranty

■ Black 100 340 816

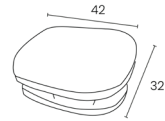

CHOCOLATE prevents muscle pain and back fatigue related to poor posture and promotes blood circulation. Adjustable in height from 10 to 16 cm and in angle from 0° to 25° thanks to its axis system with no screws. Adapts to all morphologies. Tray equipped with a non-slip support surface to support the feet naturally. Base ensuring perfect stability.

ROLLER FEET

Material: PVC, EVA foam
2 years warranty

■ Black 400 125 220

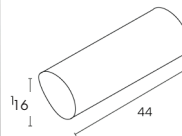

The ROLLER FEET footrest is the first cylindrical footrest allowing you to move your feet back and forth. Its smooth part is ideal to improve your blood circulation. Its multi-dimensional textured surface will allow you to enjoy the benefits of «reflexology» (barefoot use only). It is designed to withstand intensive use. The EVA foam that composes it is very resistant and will not collapse under pressure, and the hollow and rigid cylinder maintains its shape and structure.

UPDOWN

Material: ABS and silicone
10 years warranty

■ Black 400 095 456

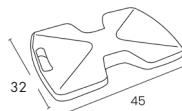
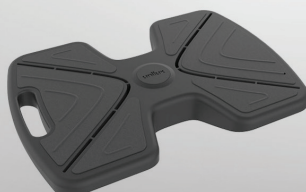

UPDOWN is an ergonomic footrest that can be used while sitting or standing. It improves circulation and reduces fatigue. It can also be used for dynamic exercises during lunch breaks. Easy to carry thanks to its ergonomic handle. Equipped with two anti-slip pads.

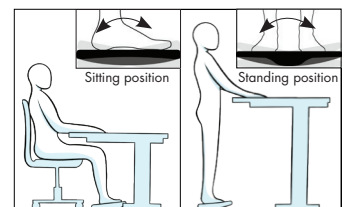

MONITOR & LAPTOP SUPPORT

People use monitor or laptop risers to create a more comfortable, efficient, and ergonomic workspace. These accessories not only enhance productivity and well-being but also contribute to a cleaner and more organized desk environment. A monitor or laptop riser allow to correctly align the eyes with the screen thus prevent RSI by reducing neck strain.

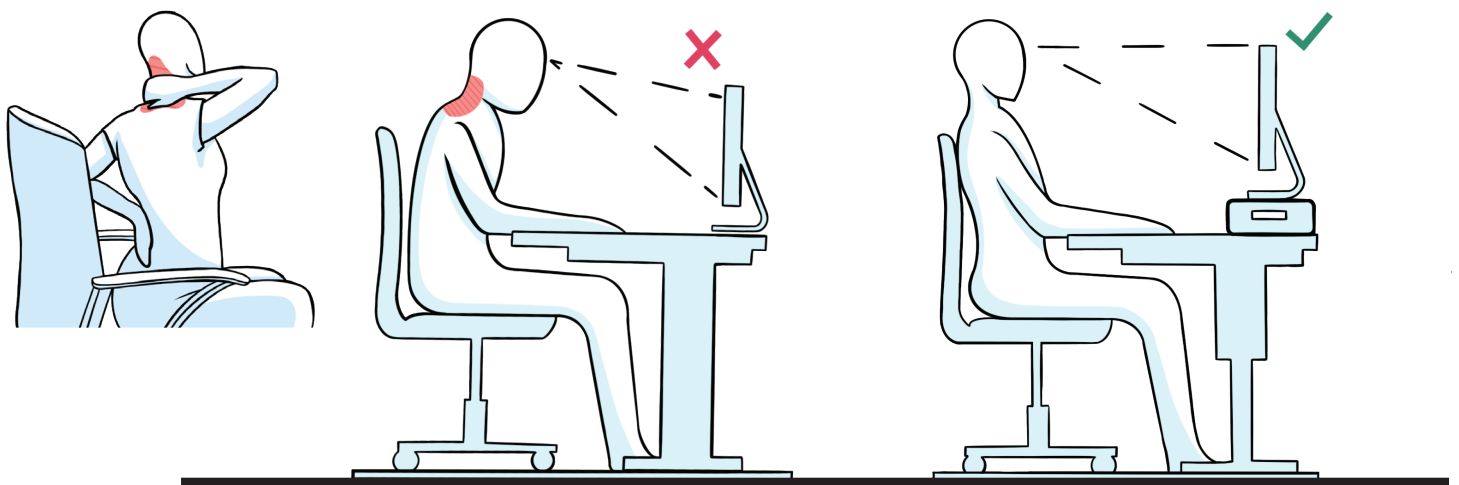

ERGO TOP

Material: recyclable aluminium
2-year warranty

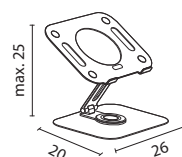
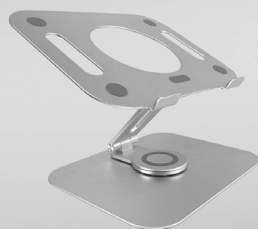

ERGO TOP laptop riser is lightweight, can be folded and is ideal to bring the screen to a comfortable viewing angle. It can be tilted from 0° to 55°. It holds the laptop horizontally and can be rotated.

■ Metal grey 400 153 725

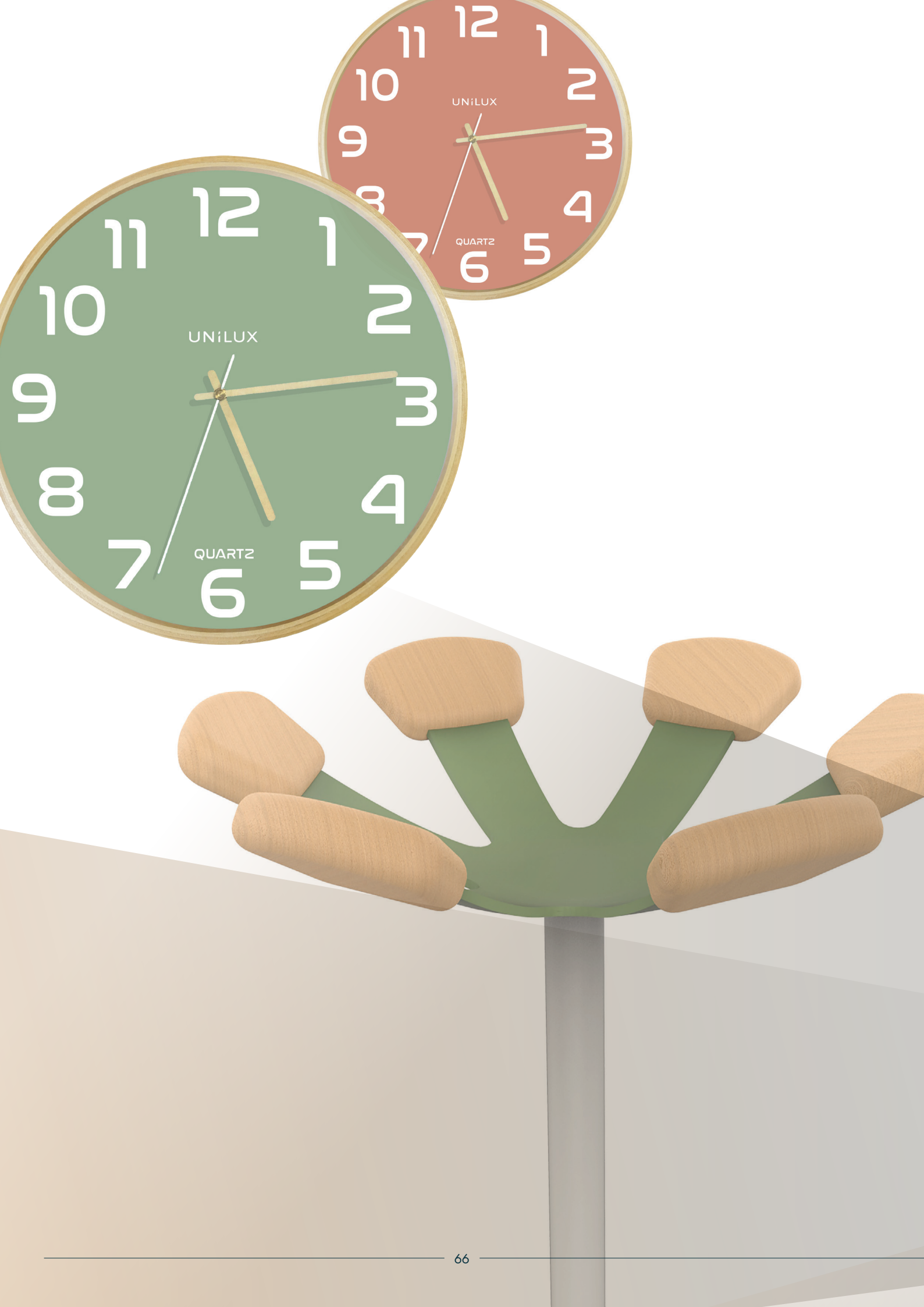

INTERIOR ACCESSORIES

In a modern, changing working world, the distinction between functional and sober office furniture and a comfortable home is becoming increasingly blurred. In times of remote and hybrid working, people work and live more flexible and the classic allocation of furniture to individual living also living areas are becoming one. With this development, the desire for a pleasant, almost homely atmosphere in the workplace is also becoming more important.

CLOCKS	68
COAT STANDS	72
COAT PEGS	75

Features



Silent movement



Radio controlled











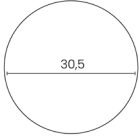



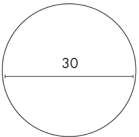

Mains connection

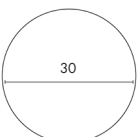
CLOCKS

In a changing world of work, the separation between office furniture and a comfortable home is becoming increasingly blurred. With this development, the desire for a warm atmosphere in the workplace is getting popular. Gone are the days when offices were only sober and functional. In addition to ergonomics, the well-being of employees also plays an important role in the modern furnishing of business premises.

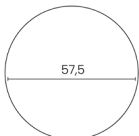
Office furniture and equipment play an important role when attracting new talents. Harmonious furnishing and an orderly environment have a positive effect on our well-being. Furnishing accessories from Unilux help to give companions a permanent place in everyday life.

<p>ARIA</p> <p>Material: plastic outline and glass dial protection. Requires 1 AA 1.5V battery (not included). 2 years warranty.</p> <p>■ Metal grey 400 094 280</p>	 	 <p>30 m</p>  <p>0,07 mA</p>	<p>ARIA is a very nice entry-level clock, ideal for individual or small collective offices. Quartz clock mechanism, based on the phenomenon of piezoelectricity: one of the least energy consuming, for a reliability of one second difference in 6 years of operation. Its large numbers ensures an effortless reading.</p>
<p>ON TIME</p> <p>Material: plastic outline and glass dial protection. Requires 4 AA 1.5V batteries (included). 2 years warranty.</p> <p>■ Black 400 094 567</p>	 	 <p>35 m</p>  <p>0,29 mA</p>	<p>ON TIME allows to choose 4 different time zones to be reactive everywhere in the world: Paris, London, Tokyo and New York. Equipped with a high-precision quartz system: The quartz pendulum mechanism, based on the phenomenon of piezoelectricity, is one of the least energy-consuming, for a reliability of one second difference in 6 years of operation.</p>
<p>MAGNET</p> <p>Material: plastic outline and glass dial protection. Notched hour/minute dial with Arabic numerals for easy reading. 1 AA 1.5V battery required (included). 2 years warranty.</p> <p>■ Metal grey 400 094 406</p>	 	 <p>150 m</p>  <p>0,22 mA</p>	<p>MAGNET is a clock, to be put on all metallic surfaces. High precision quartz system: the quartz clock mechanism, based on the phenomenon of piezoelectricity, is one of the least energy-consuming, for a reliability of one second difference in 6 years of operation. Adheres to metal surfaces: 0 do-it-yourself Thanks to its power magnets, MAGNET can be fixed on all metal surfaces without prior installation.</p> 
<p>MÉGA</p> <p>Material: plastic outline and glass dial protection. Requires 1 AA 1.5V battery (included). 2 years warranty.</p> <p>■ Black 400 094 568</p>	 	 <p>180 m</p>  <p>0,21 mA</p>	<p>MEGA is perfectly adapted to large areas (open spaces, warehouses, meeting rooms...). Very contemporary look thanks to its white numbers on a black background, it dresses with style a wall.</p>

CLOCKS

NUMI

Material: ABS / PMMA.
2 years warranty.

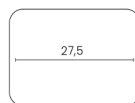

20 m

Complete digital display showing time, date and indoor temperature, adjustable via the included remote control. Smart brightness adjustment automatically adapting to ambient light. Excellent readability thanks to high-contrast orange and white LED digits on a black background. Versatile installation on a wall or desk, with mains power cable provided.



Black 400 202 319

FLO LED

Material: plastic outline and glass dial protection.
In plugged.
2 years warranty.

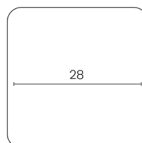

50 m

FLO LED is EED clock connected to the mains: no more batteries to change. It indicates the date and the temperature of the room. Very readable thanks to its 6 high blue numbers, it is also silent.



0,28mA



Black 400 124 566

POP

Material: plastic outline and glass dial protection.
Requires 1 AA 1.5V battery (included).
2 years warranty.

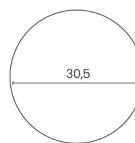

30 m

POP is a silent and colourful clock, ideal for large offices or meeting rooms. The second hand does not emit any noise: ideal for well-being and concentration in the office. 4 colours to choose from.



0,22 mA



White 400 094 282
Metal grey 400 094 283
Black 400 094 281
Green 400 094 284

MAXI POP

Material: plastic outline and glass dial protection.
Requires 1 AA 1.5V battery (included).
2 years warranty.

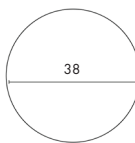
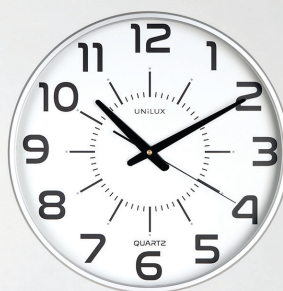

35 m

MAXI POP is a clock specially designed for collective spaces. Silent movement thanks to the second hand not emitting any noise: creates a framework favourable to the concentration and the well-being.



0,88 mA



Metal 400 094 488
Black 400 094 487

POP PL

Material: plastic outline and glass dial protection.
Requires 1 AA 1.5V battery (included).
2 years warranty.

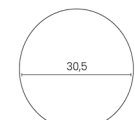

30 m

Silent movement ensuring a calm workspace conducive to concentration. Quartz mechanism delivering consistent, long-lasting precision. High-contrast display guaranteeing optimal readability.



0,20 mA



Black 400 190 878

CLOCKS

ATTRACTION

Material: plastic outline and glass dial protection.
Requires 1 AA 1.5V battery (included).
2 years warranty.

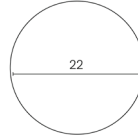

22 m



0,28 mA

ATTRACTION is a clock to be fixed on cabinets or partitions thanks to its power magnets. It can be fixed without prior installation on all metal surfaces. Very classic and discreet design. Equipped with a high precision quartz system, the mechanism of the clock is based on the phenomenon of piezoelectricity: one of the least energy consuming. Reliability of one second difference in 6 years of operation.
The second hand makes no noise.



■ Metal grey 400 094 404

INSTINCT

Material: plastic outline and glass dial protection.
Requires 1 AA 1.5V battery (included).
2 years warranty.

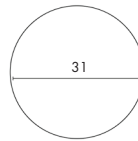

35 m



0,14 mA

INSTINCT is a classic and silent clock which finds its place in all types of environment. High precision quartz clock mechanism. Integrated digital date with the possibility of indicating the day/date, date/month, hour/minutes.

■ Metal grey 100 340 853

TEMPUS

Material: plastic outline and glass dial protection.
Requires 1 AA 1.5V battery (included).
2 years warranty.

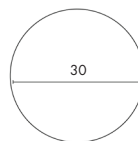

35 m



0,21 mA

TEMPUS is a wall clock perfectly adapted to the working world. High precision weather function: The dial of the TEMPUS clock is equipped with a digital thermometer display in degrees C°, allowing you to know the temperature of your working environment in real time with extreme precision. TEMPUS is a classic and modern clock with a design and a grey metal contour that will fit in any decor, from the most classic to the most contemporary.

■ Metal grey 400 094 592

PALMA BAMBOO

Material: bamboo (grass)
Requires 1 AA 1.5V battery (included).
2 years warranty.

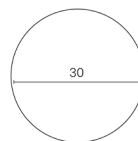

35 m



0,20 mA

PALMA BAMBOO is a silent clock in a neo-retro design, with modern lines. Its dial is made of bamboo, 100% natural. It offers a good readability because the absence of protective glass avoids reflections.
Silent second hand for a framework conducive to concentration for work.
High quality Quartz system allows a reliability of 1 second difference in 6 years of operation.

■ Black/bamboo 400 140 806

OUTDOOR - RADIO-CONTROLLED

Material: plastic outline and glass dial protection.
Requires 1 AA 1.5V battery (included).
2 years warranty.

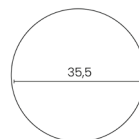

100 m













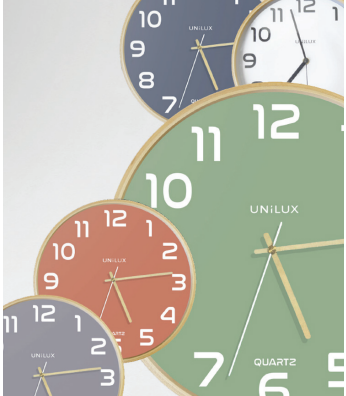
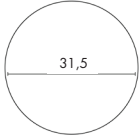

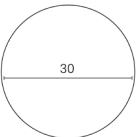
0,22 mA

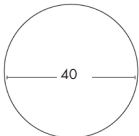
OUTDOOR is a clock that is suitable for both indoor and outdoor use. It is an intelligent clock that adjusts itself automatically and permanently by radio waves from the atomic clock in Mainzflingen. High precision: 1 second of difference maximum over 1 million years.
Product advantages: waterproof and silent, it is ideal for large indoor or outdoor spaces.
Attention, the radio-controlled clocks do not work in buildings with metal structures.

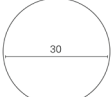
■ White/steel 400 094 566

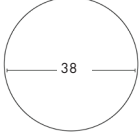

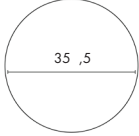
CLOCKS

<p>BALTIC</p> <p>Material: wooden outline and glass dial protection. Requires 1 AA 1.5V battery (included). 2 years warranty.</p> <ul style="list-style-type: none"> White 400 094 591 Grey 400 165 097 Green 400 165 098 Blue 400 165 110 Brick 400 165 111 			 35 m	<p>BALTIC is a clock that combines with modernity wood and glass. Very contemporary design, wooden structure that preserves from rust and bumps in case of fall. Its design helps preserve natural resources for future generations. Eco-responsible approach. Silent second hand for a framework conducive to concentration for work.</p>
<p>WETTY</p> <p>Material: steel frame and mineral glass dial protection. Requires 1 AA 1.5V battery (included). 2 years warranty.</p> <ul style="list-style-type: none"> black/steel 400 140 807 			 30 m	<p>WETTY is a design clock equipped with a thermometer and a hydrometer, allowing you to know the indoor temperature (0 to 50° C) and humidity (30 to 100%) of your workspace. Its white numbers on a black background increase the contrast and make it easy to read, even from a distance. Silent handwheel for an environment conducive to concentration for work.</p>
<p>HELLO</p> <p>Material: 100% PET (50% recycled/50% recyclable) Requires 1 AA 1.5V battery (included). 2 years warranty.</p> <ul style="list-style-type: none"> Beige 400 165 095 			 35 m	<p>HELLO is the first acoustic wall clock made entirely of PET (50% recycled/50% recyclable). With an excellent sound absorption coefficient of 0.8 and in combination with the NEXUS floor lamp, HELLO will reduce noise pollution in work areas. Its large diameter of 40 cm allows maximum legibility up to 35 m thanks to the large size of its digits. Its silent second hand creates an environment conducive to concentration for work.</p>
<p>MAXI</p> <p>Material: plastic frame and glass dial. Requires 1 AA 1.5V battery (included). 2 years warranty.</p> <ul style="list-style-type: none"> Metal grey 400 094 562 Black 400 094 561 			 35 m	<p>MAXI / MAXI WAVE is a silent clock ideal for collective spaces. Radio controlled technology: automatically and permanently adjusted by radio waves from the Mainfligen atomic clock (no more approximate clocks). High precision: maximum 1 second difference in 1 million years.</p>
<p>MAXI WAVE</p> <ul style="list-style-type: none"> Metal grey 400 094 565 Black 400 094 564 			 150 m	<p>Please note that radio-controlled clocks do not work in buildings with metal structures.</p>
<p>STATION RADIO-CONTROLLED</p> <p>Material: epoxy-finished steel outline and glass dial protection. Requires 1 AA 1.5V battery (included). 2 years warranty.</p> <ul style="list-style-type: none"> White/steel 400 124 567 			 100 m	<p>STATION is a clock with a timeless design, it is radio-controlled and silent. Its stainless steel frame makes it very robust. Attention, the radio-controlled clocks do not work in buildings with metal structures.</p>

COAT STANDS



BORA BAMBOO

BOURGEON

Material: Acier / ABS.
2 years warranty.

■ Metal Grey 400 187 743

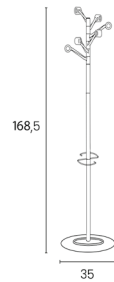

6



6



4 min

6 rotating hooks to hang clothes and accessories without marking them. Open design ideal for holding hangers, scarves and more. Silicone drip tray protecting the weighted base from moisture.

TOTEM

Material: Steel / ABS.
2 years warranty.

■ Black 400 188 801

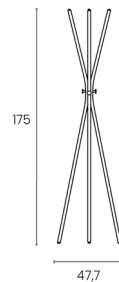
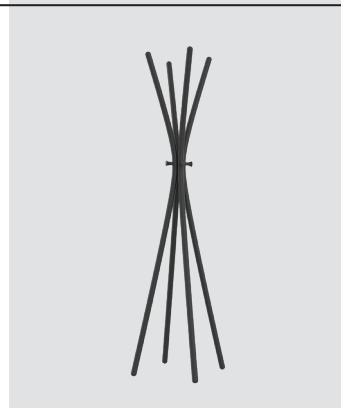

8



0



4 min

4 practical hooks for hanging clothes. Robust metal core for perfect stability. Clean, modern design that fits seamlessly into any environment. Tool-free assembly for quick and easy installation.

SNOOD

Material: Steel / FSC Wood.
2 years warranty.

■ Black/Wood 400 202 318

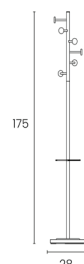

6



6



5 min

Six offset hooks with smooth, rounded shapes that prevent garments from deforming. Weighted base ensuring excellent stability. Quick assembly in just 5 minutes. FSC-certified beech wood for durable, responsible manufacturing.

COAT STANDS

AURORA

Material: epoxy painted steel barrel, beechwood pegs.
2 years warranty.

- White 400 168 673
- Green/white 400 168 671
- Red/white 400 168 672

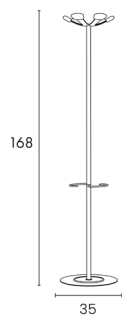

- 6
- 6

4 min

AURORA is a modern and slender coat rack that will fit harmoniously into workplaces and reception areas. Equipped with 6 beechwood coat hooks, each with a weight of 5 kg. The steel umbrella stand with drainer can hold up to 6 umbrellas. ideal in high traffic areas, its 4mm thick steel base ensures good stability.

ACCESS

Material: base, shaft, peg axle and umbrella stand made of steel, wooden shaft part and plastic pegs.
2 years warranty.

- Black 400 095 391
- White/beech 400 095 392

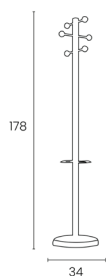

- 6
- 6

4 min

ACCESS is a coat hanger with six rounded hooks: easy and useful hanging of clothes. Essential and classic accessory. Fits perfectly in any office.

BORA BAMBOO

Material: epoxy painted steel barrel, steel and real bamboo pegs.
2 years warranty.

- White/bamboo 400 153 729
- Black/bamboo 400 140 808

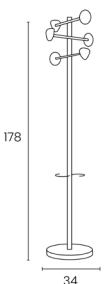

- 6
- 6

4 min

BORA BAMBOO is a neo-retro design coat rack with 3 coat hooks and a bamboo base decoration. It is equipped with an umbrella stand for up to 6 umbrellas and a drainer. These wide hooks will not distort clothes. The wide base with a diameter of 34 cm ensures perfect stability.

BOUQUET

Material: base and shaft in epoxy painted steel; pegs in steel and real wood.
2 years warranty.

- Metal grey/beech 400 069 048

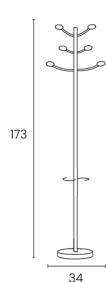

- 6
- 6

4 min

BOUQUET is a coat rack equipped with 6 pegs. Wide and rounded, they do not distort the clothes. The weighted base guarantees a perfect stability of the product. Equipped with an umbrella holder and a drainer

ACCUEIL

Material: epoxy painted steel base and shaft; nylon, abs and polypropylene coat hook; polypropylene umbrella holder and drip tray.
2 years warranty.

- Black 100 340 694
- Metal grey 100 340 698

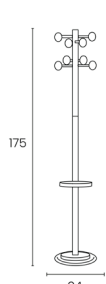
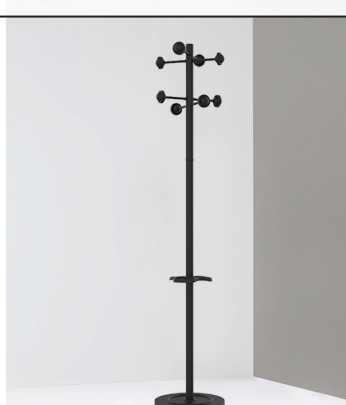

- 8
- 9

4 min

ACCUEIL is a coat rack equipped with 8 round hooks arranged in staggered rows to facilitate the hanging of clothes. Equipped with non-slip edges and do not distort clothes. Swivel head for easy access to coats. Weighted base guarantees perfect stability of the product. Equipped with a height-adjustable umbrella holder and a large drainer.

COAT STANDS

TIPY

Material: bamboo and steel junction piece.
2 years warranty.

Bamboo 400 153 153

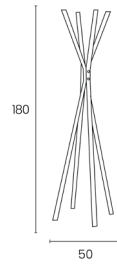

TIPY is a sturdy coat rack with a Scandinavian design. The 4 hooks are designed so that they do not damage the clothes.

SPIRIT

Material: ADX steel, epoxy paint, fiber filled plastic connectors, real wood hangers.
2 years warranty.

Metal grey 100 340 626

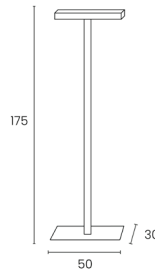

SPIRIT is a coat rack with a clean design. SPIRIT will accommodate all types of clothing. The studied shape of the hangers ensures the protection of the clothes: no deformation, even in long storage. They can be positioned on the upper carrying bar, which is 50cm long. Delivered with 6 hangers in solid wood varnished mahogany.

CYPRES

Material: base, shaft and peg support in epoxy-finished steel, umbrella holder and drip tray in polypropylene, pegs in anodized aluminum.
2 years warranty.

Metal grey 100 340 640
Black 100 340 639

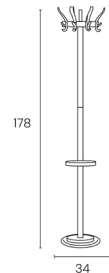

CYPRES is a coat rack with 8 triple hooks fixed on a high quality shaft. Swivel head for easy access to coats. Weighted base guarantees perfect stability of the product. Equipped with a height-adjustable umbrella stand and a large drainer.

HAKEA

Material: chromed steel barrel with epoxy paint for the pegs.
2 years warranty.

Chrome/black 400 095 393

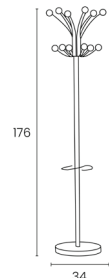

HAKEA is a classic chrome coat rack. It has a rotating head with 12 pegs. Its rounded pegs ensure that clothes are not distorted. This coat rack has an excellent stability thanks to its base of 6 kg and 34 cm diameter. It is equipped with a height-adjustable umbrella stand with a capacity of 6 umbrellas.

FOLDY

Material: steel with metal grey epoxy paint and ABS.
2-year warranty.

Chrome 400 050 665

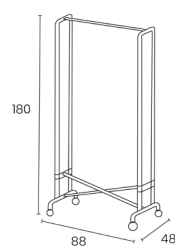

FOLDY is a functional and sturdy rack that optimises space: it unfolds in seconds without effort for immediate use. The folding system allows the product to be stored without taking up any space. Once folded, it occupies only 10x48 cm of floor space: easy storage. Swivel wheels: easy to move. Delivered assembled for immediate use: no assembly operations.

COAT PEGS



AURORA

Material: beechwood pegs and metal
peg stands with epoxy paint.
2-year warranty.

- 1 coat peg white/beech 400 177 894
- 2 coat pegs white/beech 400 177 882
- 3 coat pegs white/beech 400 177 884

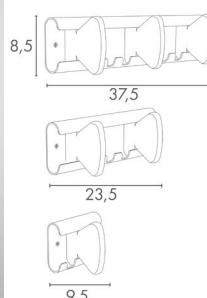
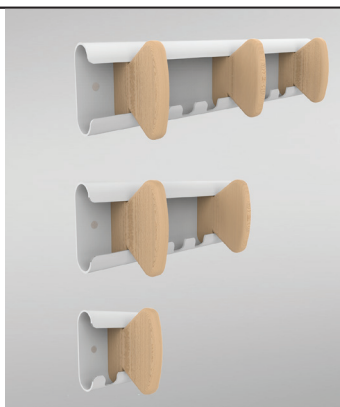

AURORA coat pegs with its Scandinavian design and the presence of wood, these coat hooks will bring a touch of warmth and will be able to integrate harmoniously in the places of work and reception.

The rounded hooks ensure that the clothes are held in place perfectly and that they are not damaged. The hooks allow you to hang accessories such as scarfs, handbags, etc.

Delivered with an assembly kit containing screws and dowels.

Maximum load: 5 kg per hook.

COAT PEGS

FIL MAGNETIC

Material: ABS and glossy cicolac.
2 years warranty.

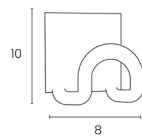

FIL MAGNETIC can be attached to any metal support (no drilling required). Its rounded shape has been studied to respect the clothes it supports. Timeless and universal lines. Maximum load: 12 kg.

■ Black 100 340 762



STEELY MAGNETIC

Material: steel and PVC end cap.
2-year warranty.

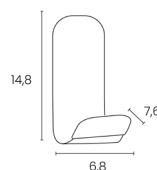

STEELY MAGNETIC can be attached to any metal support (no drilling required). Equipped with a plastic and rounded tip that respects clothing. Contemporary and slender shape. Maximum load: 12 kg.

■ Black 100 340 733
■ Metal grey 100 340 734



CYPRES 2

Material: anodised aluminium pegs, steel stand.
2-year warranty.

■ Black/alu 100 340 804

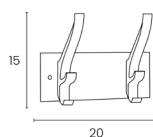

The CYPRES double coat hook has been designed to preserve the integrity of the garments it supports. Clean, dynamic lines. Ideal for modern offices. Supplied with an assembly kit containing screws and plugs.

CYPRES 4

Material: anodised aluminium pegs, steel stand.
2-year warranty.



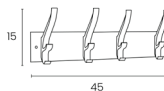













■ Black/alu 100 340 805





































SUMMARY

Desk Lamps

Product	Colour	Item Code	Page
AVA 	Black Light Green Brick Orange	400190955 400190958 400190959 400190980	p. 36
BAYA BAMBOO 	Black/Bamboo	400140800	p. 28
BAYA BAMBOO 	White/Bamboo	400153645	p. 28
DIVA 	Black	400124560	p. 32
EASY 	Black	400093833	p. 31
ELITE LUMINO 	Black	400202310	p. 24
GALY 1800 	White	400132274	p. 35
JACK 	Black	400077430	p. 32
JAZZ 	White/Metal grey	400093836	p. 34
JOKERLED 	Black	400064432	p. 32
JOKER OCEANIS 	Black/Blue	400179658	p. 32
KAPA 	White	400188497	p. 36
KATZ 	Black	400188806	p. 36
LINKA 	Black	400124484	p. 35
LOOMPA 	Black Green Brick Orange	400202311 400202312 400202313 400202314	p. 36
LUMILIGHT 	Black	400177869	p. 29

Product	Colour	Item Code	Page
MAMBOLED 	Black Metal grey	400033683 400033684	p. 28
MAMBOLED 2.0 	Black Metal grey	400140801 400140847	p. 28
NELLY 	White	400124483	p. 35
NOVY LED 	Black	400188811	p. 33
OMEGA 	Black White	400202315 400202316	p. 29
POPY 	White Black	400124478 400153693	p. 34
PURELINE 	White Metal grey	400165091 400172851	p. 27
RUMBALED 	Black	400093720	p. 31
SENZA 2 	Metal grey	400092054	p. 27
SOL 	White	400077404	p. 31
SOL 	Black	400077402	p. 31
SOL 	Red	400077406	p. 31
SOL 	Blue	400077405	p. 31
STRATA 	White	400165231	p. 25
STRATA 	Black	400124562	p. 25
STRATA BASE 	Black White	400188448 400188446	p. 24







Desk Lamps

Product	Colour	Item Code	Page
STRATA 80 	Black	400199208	p. 24
STRATA LUMINO 	Black	400207194	p. 24
SUCCESS 66/80 	Black (66)	400093600	p. 28
SUCCESS 66/80 	Black (80)	400093579	p. 28
SUCCESS CHROME 	Chrome	400092123	p. 28
SUNLIGHT 	Black	400110128	p. 22
SWINGOLED 	Black	400093838	p. 27
SWINGOLED 	White	400093839	p. 27
SWINGOLED 2.0 	Black	400190981	p. 29
TAMY 	White	400165012	p. 31
TAMY 	Grey	400165986	p. 31
TAMY 	Black	400172506	p. 31
TAMY 	Green	400165015	p. 31
TAMY 	Blue	400165017	p. 31
TAMY 	Pink	400165018	p. 31
TERRA 	Metal grey	400077409	p. 34















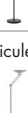

Desk Lamps

Product	Colour	Item Code	Page
TRAVELIGHT 	Black	400140802	p. 25
TWISTLED 	Black	400165037	p. 34
VICKY 	White/Beech	400110084	p. 32
VICKY 	Black/Beech	400153732	p. 32
VISIOLIGHT 	Grey	400153723	p. 25
VENUSLIGHT 	White	400165033	p. 29
ZENITH 	Black Metal Grey	400188588 400188589	p. 29
MINI ZOOM LED 	White	400108074	p. 37
ZOOM LED 	White	400108073	p. 37











Light Therapy Lamps

Product	Colour	Item Code	Page
MOBILLY 	White/Beech	400180141	p. 39
MOBILLY 	Black/Bamboo	400178700	p. 39
WELLBI 	White	400179590	p. 39
SUNACTIV 2 	White	400159056	p. 39
SLIMSTYLE 3 	Black	400149953	p. 39
SUNDESK 3 	Black	400149954	p. 39

SUMMARY

Product	Colour	Item Code	Page
ATLAS 	Black	400202686	p. 45
BALY BAMBOO 	Black/Bamboo	400140805	p. 42
BALY BAMBOO 	White/Bamboo	400153731	p. 42
COCOON 	Black	400202317	p. 45
DELY 2.0 	Black	400153721	p. 41
DELY 2.0 	Metal grey	400153720	p. 41
DELY 2.0 articulated 	Black	400153698	p. 42
DELY 2.0 articulated 	Metal grey	400153697	p. 42
FIRST LED 	Black	400153696	p. 41
FIRST LED 	Metal grey	400153695	p. 41
FIRST LED articulated 	Black	400153694	p. 41
LEDDY 	White	400165031	p. 41
LIXUS 	Metal grey	400079771	p. 45
LUMILIGHT 	Black	400177890	p. 41
NEXUS 	White	400165148	p. 45
OPUS 	Black	400188813	p. 44







Uplighter

Product	Colour	Item Code	Page
PRYSKA 	White/Beech	400110157	p. 43
PRYSKA 	Black/Beech	400153677	p. 43
STRATUS 	Metal grey	400124564	p. 45
VARIAGLASS 	Metal grey	400090473	p. 42
VARIALUX 	Metal grey	400090468	p. 42
VARIALUX articulated 	Black	400090469	p. 42
VARIALUX articulated 	Metal grey	400090471	p. 42
VERSUS 	Black	400188812	p. 44
VERSUS 	White	400191230	p. 44
ZELUX 	Metal grey	400100711	p. 43

Ergonomic accessoires

Product	Colour	Item Code	Page
BALANCY 	Wood Beech	400188804	p. 63
CHOCOLATE 	Black	100340816	p. 64
CHRYSA LIS 	Black	100340820	p. 64
CHRYSA LIS OCEANIS 	Black/Blue	400179659	p. 64
NYMPHEA 	Black	100340822	p. 64
ORIGIN 	Black	100340819	p. 63
ROLLER FEET 	Black	400125220	p. 64
UPDOWN 	Black	400095456	p. 64

AXIO Monitor Arms

Product	Colour	Item Code	Page
SINGLE MECHANICAL ARM 	Black	400204097	p. 50
DOUBLE MECHANICAL ARMS 	Black	400204099	p. 50
ELITE LUMINO SCREEN 	Black	400207202	p. 51
STRATA LUMINO SCREEN 	Black	400207200	p. 51
STRATA SCREEN 	Black	400207201	p. 51
KORO SINGLE GAZ SPRING ARM 	Black	400207190	p. 54
KORO DOUBLE GAZ SPRING ARM 	Black	400207191	p. 54

Ergonomic accessoires

Product	Colour	Item Code	Page
ERGO BOOST 	White/Grey	400165092	p. 61
ERGO LEG 	Metal grey/Black	400165094	p. 62
ERGO SPHERE 	Grey	400165093	p. 62
MOOVE 	Black	400110242	p. 61

Home Office Desk

Product	Colour	Item Code	Page
HOMY 	White/Beech	400165232	p. 60

Monitor & Laptop Support

Product	Colour	Item Code	Page
ERGO TOP 	Metal grey	400153725	p. 65

AXIO Monitor Arms

Product	Colour	Item Code	Page
HEAD VESA CROSSBAR 1 SCREEN GAZ SPRING ARM MECHANICAL ARM MAST 58 CM LAPTOP SUPPORT ANGLED MECHANICAL ARM SLIDING CONNECTOR GROMMET FIXATION DESK	Black	400206626 400206624 400206621 400206620 400207193 400206622 400207189 400206625 400207192	p. 52

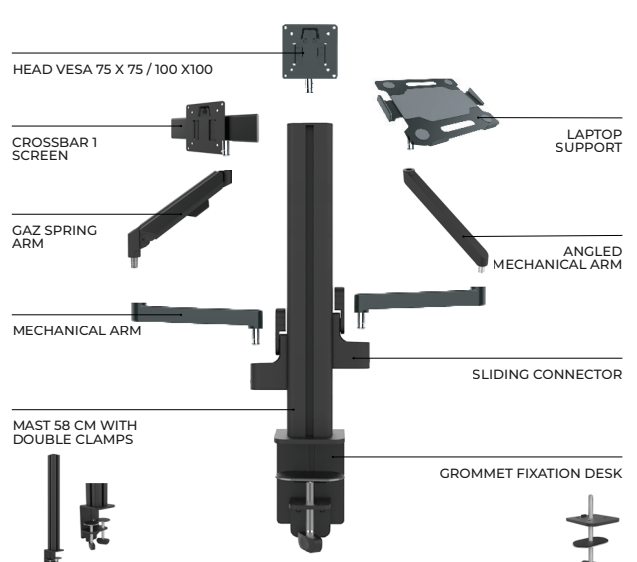













The diagram illustrates the various components of the AXIO Monitor Arms system. It shows a central vertical mast (MAST 58 CM WITH DOUBLE CLAMPS) that supports several different types of arms and screens. Components include: HEAD VESA 75 X 75 / 100 X 100, CROSSBAR 1 SCREEN, GAZ SPRING ARM, MECHANICAL ARM, LAPTOP SUPPORT, ANGLED MECHANICAL ARM, SLIDING CONNECTOR, and GROMMET FIXATION DESK. The diagram also shows how these components are assembled onto a desk.

















SUMMARY

Clocks

Product	Colour	Item Code	Page
ARIA 	Metal grey	400094280	p. 68
ATTRACTION 	Metal grey	400094404	p. 70
BALTIC 	White/Beech	400094591	p. 71
BALTIC 	Green/Beech	400165098	p. 71
BALTIC 	Brick/Beech	400165111	p. 71
BALTIC 	Blue/Beech	400165110	p. 71
BALTIC 	Grey/Beech	400165097	p. 71
FLO LED 	Black	400124566	p. 69
HELLO 	Beige	400165095	p. 71
INSTINCT 	Metal grey	100340853	p. 70
MAGNET 	Metal grey	400094406	p. 68
MAXI POP 	Black Metal grey	400094487 400094488	p. 69
MAXI WAVE 	Black Metal grey	400094564 400094565	p. 71
MEGA 	Black	40094568	p. 68
NUM 	Black	400202319	p. 69
ONTIME 	Black	400094567	p. 68

Product	Colour	Item Code	Page
OUTDOOR 	Grey	40094566	p. 70
PALMA 	Bamboo	400140806	p. 70
POP 	White	400094282	p. 69
POP 	Metal grey	400094283	p. 69
POP 	Black	400094281	p. 69
POP 	Green	400094284	p. 69
POP PL 	Black	400190878	p. 69
STATION 	Grey	400124567	p. 71
TEMPUS 	Metal grey	400094592	p. 70
WAVE 	Black	400094561	p. 71
WAVE 	Metal grey	400094562	p. 71
WETTY 	Grey	400140807	p. 71

Coat Stands

Product	Colour	Item Code	Page
ACCES 	Black	400095391	p. 73
ACCES 	Black/Beech	400095392	p. 73
ACCUEIL 	Metal grey	100340698	p. 73
ACCUEIL 	Black	100340694	p. 73
AURORA 	White	400168673	p. 73
AURORA 	White/Green	400168671	p. 73
AURORA 	White/Brick	400168672	p. 73
BORA 	White/Beech Black/Beech	400153729 400140808	p. 73
BOUQUET 	Metal grey/Beech	400069048	p. 73
BOURGEON 	Metal grey	400187743	p. 72
CYPRES 	Black Metal grey	100340639 100340639	p. 74
HAKEA 	Black/Chrome	400095393	p. 74
SNOOD 	Black/Wood	400202318	p. 72
SPIRIT 	Metal grey	100340626	p. 74
TIPY 	Beech	400153153	p. 74
TOTEM 	Black	400188801	p. 72

Coat Pegs

Product	Colour	Item Code	Page
AURORA x1 AURORA x2 AURORA x3	White/Beech	400177894 400177882 400177884	p. 75
CYPRES x2 CYPRES x4	Black/Metal grey	100340804 100340805	p. 76
FIL	Black	100340762	p. 76
STEELY	Black	100340733	p. 76
STEELY	Metal grey	100340734	p. 76
FOLDY	Metal grey	400050665	p. 74

NOTES:

UNILUX

HAMELIN GmbH
Robert-Hamelin-Str. 1
31028 Gronau (Leine)
GERMANY
Tel: +49 5182 901 0
info.hamelinde@hamelinbrands.com
www.my-unilux.com

HAMELIN A/S
Hirsemarken 5, st. th.
3520 Farum
DANMARK
Tel: +45 48 16 50 00
info-dk@hamelinbrands.com
www.hamelin.dk